

35
135

DENON

Hi-Fi Component

SERVICE MANUAL

STEREO CASSETTE TAPE DECK

MODEL DR-M33HX/DR-M44HX

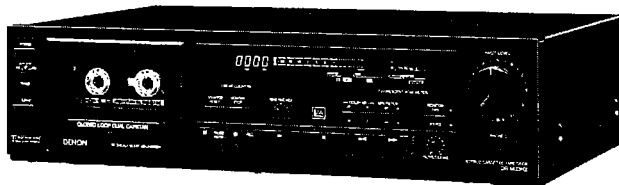

DR-M33HX

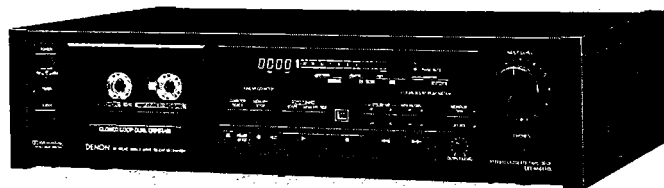

DR-M44HX

NIPPON COLUMBIA CO., LTD.

TABLE OF CONTENTS

MAIN FEATURES	2
SPECIFICATIONS	3
PARTS NAMES AND FUNCTIONS	4 ~ 5
BLOCK DIAGRAM	6
LEVEL DIAGRAM	7
OUTLINE OF THE MECHANISM CONTROL MICROCOMPUTER	8
DISASSEMBLY INSTRUCTIONS	9 ~ 11
ADJUSTING AND CHECKING THE MECHANISM SECTION	11 ~ 14
ADJUSTING THE ELECTRICAL SECTIONS	14 ~ 17
PARTS LIST OF P.W. BOARD	18 ~ 21
PARTS LIST OF EXPLODED VIEW (DR-M33HX)	22
EXPLODED VIEW OF CABINET AND CHASSIS GROUP (DR-M33HX)	23
PARTS LIST OF P.W. BOARD, ACCESSORIES AND PACKING GROUP	24
PARTS LIST OF MECHANISM 83 UNIT (DR-M33HX)	24
EXPLODED VIEW OF MECHANISM 83 UNIT (DR-M33HX)	25
WIRING DIAGRAM (DR-M33HX)	26
SCHEMATIC DIAGRAM OF HX PRO UNIT (DR-M33HX)	27
P.W. BOARD OF KU-5620 HX PRO UNIT (DR-M33HX)	27
SCHEMATIC DIAGRAM OF AUDIO AMP UNIT (DR-M33HX)	28
P.W. BOARD OF KU-5610 AUDIO AMP UNIT	29
SCHEMATIC DIAGRAM OF POWER AND LOGIC UNIT (DR-M33HX)	30
P.W. BOARD OF KU-5211 POWER AND LOGIC UNIT	31
P.W. BOARD OF KU-5220 CONTROL UNIT AND KU-5650 MECHANISM UNIT	31
SCHEMATIC DIAGRAM OF FL COUNTER UNIT (DR-M33HX)	32
P.W. BOARD OF KU-5640 FL COUNTER UNIT	33
EXPLODED VIEW OF CABINET AND CHASSIS GROUP (DR-M44HX)	34
PARTS LIST OF EXPLODED VIEW (DR-M44HX)	35
PARTS LIST OF MECHANISM 53 UNIT (DR-M44HX)	36
EXPLODED VIEW OF MECHANISM 53 UNIT (DR-M44HX)	37
WIRING DIAGRAM (DR-M44HX)	38
SCHEMATIC DIAGRAM OF HX PRO UNIT (DR-M44HX)	39
P.W. BOARD OF KU-5621 HX PRO UNIT	39
SCHEMATIC DIAGRAM OF AUDIO AMP UNIT (DR-M44HX)	40
P.W. BOARD OF KU-5611 AUDIO AMP UNIT	41
SCHEMATIC DIAGRAM OF POWER AND LOGIC UNIT (DR-M44HX)	42
P.W. BOARD OF KU-5212 POWER AND LOGIC UNIT	43
P.W. BOARD OF KU-5221 CONTROL UNIT	43
SCHEMATIC DIAGRAM OF FL COUNTER UNIT (DR-M44HX)	44
P.W. BOARD OF KU-5641 FL COUNTER UNIT	45
SCHEMATIC DIAGRAM OF CTS UNIT (DR-M44HX)	46
P.W. BOARD OF KU-0451 CTS UNIT	47
SCHEMATIC DIAGRAM OF CAPSTAN SERVO UNIT (DR-M44HX)	48
P.W. BOARD OF KU-0445-2 CAPSTAN SERVO UNIT	48

MAIN FEATURES

- Computer-controlled servo technology
 - Direct drive closed-loop dual-capstan tape transport (DR-M44HX)
 - Closed-loop dual-capstan tape transport (DR-M33HX)
 - Silent, soft-touch controls provide maximum ease-of-use.
 - Computer-controlled, full-logic tape controls enable fool-proof operation.
- Three-head design utilizes DENON's new SF record/playback combination head assembly.
- Dolby HX PRO head room extension system
- Computing linear counter with memory stop.
- Auto tuning system provides automatic for level and EQ. (DR-M44HX)
- Dolby-C noise reduction systems (Double Dolby System).
- Extended range, dual-color fluorescent peak meters with auto peak hold.
- Auto tape selector.
- Remote control connection terminal.
- High-grade 5-pole DC reel drive motor.
- Bias fine adjustment (DR-M33HX)

SPECIFICATIONS

Type	Vertical tape loading 4-track 2-channel stereo cassette tape deck
Heads	SF Record/Playback combination head x 1 Erase head (Ferrite) x 1
Motors	FG Servo Direct Drive motor (for capstan) x 1 (DR-M44HX) Electronic servo DC motor (for capstan) x 1 (DR-M33HX) 5-pole DC motor (for reel winding) x 1
Tape Speed	4.8 cm/sec.
Fast forward, rewind time.	Approx. 80 sec. with a C-60 cassette
Recording bias	Approx. 105 KHz
Overall S/N ratio	Dolby C NR on ... 75 dB (CCIR/ARM)
(at 3% THD level)	
Overall frequency response.	25 ~ 20,000 Hz \pm 3dB (at -20 dB METAL TAPE)
Channel separation	more than 40 dB (at 1 KHz)
Crosstalk	more than 65 dB (at 1 KHz)
Wow & flutter	0.035% w.rms (DR-M44HX) 0.04% w.rms (DR-M33HX)
Inputs	
Line	77.5 mV (-20dB) input level at maximum Input impedance: 50 Kohm unbalanced
Outputs	
Line	775 mV (0 dB) output level at maximum (with 47 Kohm load, recorded level of 200 pwb/mm)
Headphone	1.2 mW output level at maximum (optimum load impedance 8 ohm ~ 1.2 Kohm)
Accessories	parallel pin cord x 2
Power supply	50/60 Hz compatible, voltage is shown on rating label
Power consumption	25W (DR-M44HX), 24W (DR-M33HX)
Dimensions	434 (W) x 115 (H) x 286 (D) mm (DR-M33HX) 464 (W) x 115 (H) x 286 (D) mm (DR-M44HX)
Weight	5.6 kg (DR-M33HX) 6.3 kg (DR-M44HX)

- Above specification and design styling are subject to change without notice for improvement. Dolby noise reduction and HX PRO headroom extension manufactured under license from Dolby Laboratories Licensing Corporation. HX PRO originated by Bang and Olufsen. "Dolby", the double-D symbol, and "HX PRO" are trademarks of Dolby Laboratories Licensing Corporation.

WARNING:

1. Component parts

Parts marked with  and/or shading in this service manual have special characteristics important to safety. Be sure to use the specified parts for replacement.

2. Leakage current

Before returning the appliance to customer, test the leakage current when the power plug is connected. Use a calibrated (with an error of not more than 5%) leakage current tester and measure the leakage current from any exposed metal to the earth ground. Reverse the power plug polarity and test the above again.

Any current measured MUST NOT EXCEED 0.5 milliamps. Corrective measure must be taken if it exceeds the limit.

PART NAMES AND FUNCTIONS

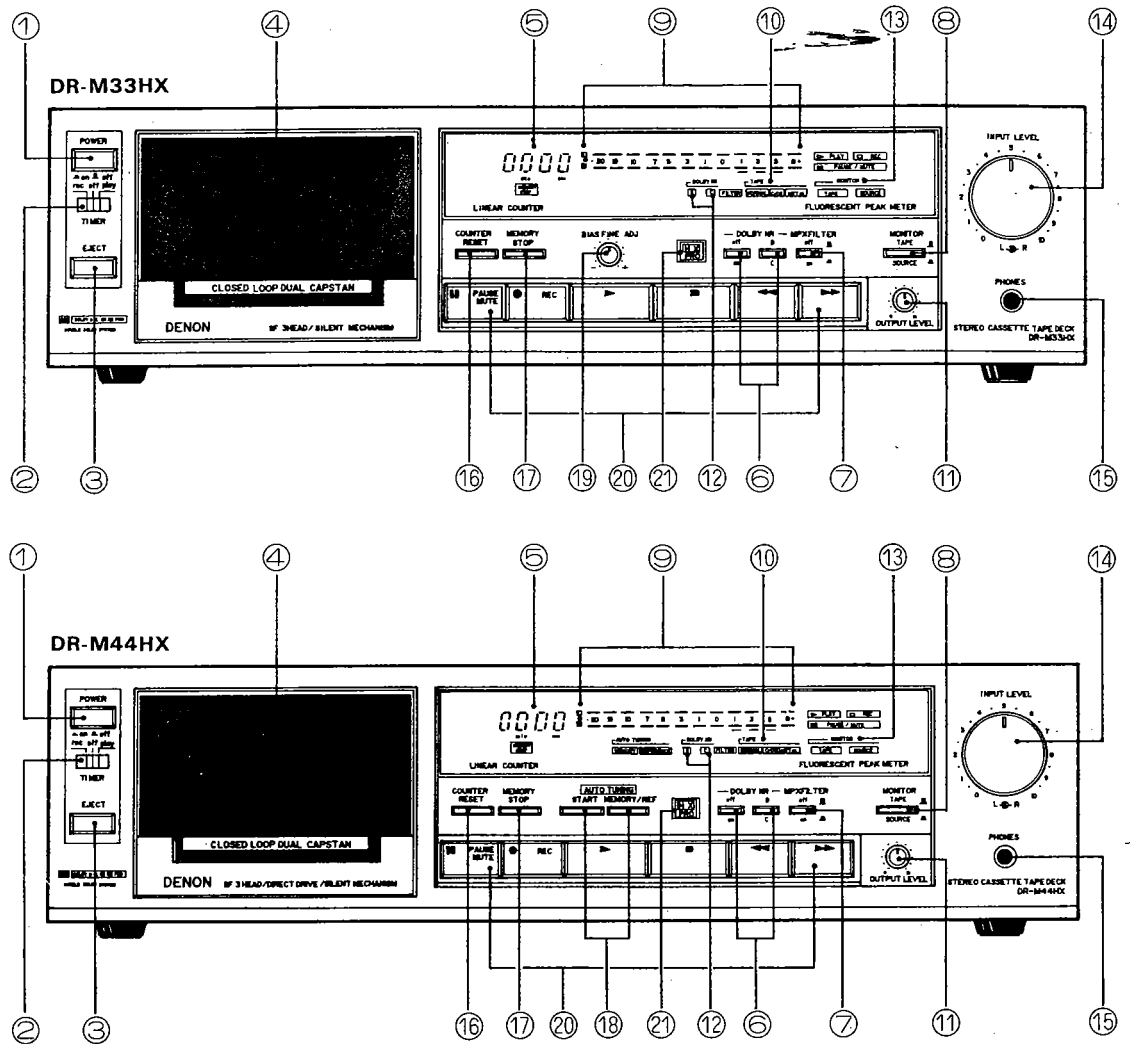

1. POWER switch

Controls the supply of AC power to the deck. One push turns the deck on, a second push turns it off. The deck remains in a stand-by (non-operative) mode for approximately 4 seconds after it is switched on.

2. TIMER switch

This switch is provided for use with an optional audio timer for unattended recording or morning-alarm playback. For non-timer operation, this switch should be set in the "off" position.

3. EJECT button

Press this button to eject the cassette. When the deck is operating (tape is running), press the stop (■) key first to stop the tape transport; then press the eject button.

4. CASSETTE COMPARTMENT COVER

If this compartment cover is not closed completely, the deck's transport controls will remain inoperative.

5. LINEAR TAPE COUNTER

Tape-passage is indicated digitally in minutes and seconds.

6. DOLBY NR switches

The left Dolby NR switch activates (in) or deactivates (out) the deck's Dolby noise reduction circuitry. The right switch selects between Dolby B-Type (out) or C-Type NR (in).

7. MPX FILTER switch

The MPX FILTER switch should be used to prevent interference with the Dolby NR circuit when making Dolby NR encoded recordings of FM stereo programs. When making Dolby NR encoded recordings from any program source other than FM stereo, leave this switch in the "off" (out) position.

8. MONITOR switch

The SOURCE (in) position of this switch allows you to

monitor the source program before it is recorded. The TAPE (OUT) position of this switch is used for tape playback monitoring or simultaneous monitoring during recording.

9. FLUORESCENT PEAK METERS

These meters indicate recording or playback peak levels for each channel. For peak levels exceeding -1dB, the Auto Peak Hold Feature holds the peak level reading for approximately 1.5 seconds.

10. TAPE SELECT indicator

This indicator light is interlocked with the Auto Tape Select feature which automatically adjusts the deck to the type of tape in use. (NORMAL, CrO₂, or METAL).

11. OUTPUT LEVEL control

This control adjusts playback, recording monitor, and headphones output levels for the both channels simultaneously.

12. NR SYSTEM indicator

This indicator light is interlocked with the Dolby NR switch and informs the user that Dolby NR is in use as well as which (B or C) Type.

13. MONITOR indicator

This indicator light is interlocked with the MONITOR switch to inform the use of the selected monitoring source - TAPE or SOURCE.

14. INPUT LEVEL controls

These controls are used to adjust recording levels for each channel. The front control is for the left channel; the rear control for the right channel.

15. PHONES jack

For private music enjoyment without disturbing others, or for monitoring a recording, a set of headphones may be plugged in. Impedance is from 8 to 1200 ohms.

16. RESET button

Operation of the button resets the counter to all zero.

17. MEMORY STOP button

During rewinding operations, the tape will stop at the "0000" counter point automatically when this button is pressed in.

18. AUTO TUNING system (DR-M44HX only)

By pushing this button, the deck automatically adjusts itself for the optimal recording characteristics of the tape that is being used.

19. Bias Fine Adjustment (for NORMAL and CrO₂ tape) (DR-M33HX only)

Adjust the bias according to the tape characteristics. Standard biasing is obtained at the center click-stop position.

20. Tape Transport Controls

▶	▶ PLAY KEY	Press to playback tape.
■	■ STOP KEY	Press to stop tape in any mode.
◀◀	◀◀ REW KEY	Press for fast rewind.
▶▶	▶▶ FF KEY	Press for fast forward tape winding.
● REC	● RECORD KEY	To begin recording, press the RECORD and PLAY keys simultaneously. If only the RECORD key is pressed, the deck is placed in the REC PAUSE (record standby) mode.
" PAUSE MUTE	" PAUSE/MUTE KEY	The PAUSE key causes the tape to stop momentarily during recording or to mute the recording input to create blank (non-recorded) portions on the tape

21. HX PRO indicator

This indicator lights when the power is on to indicate provision of the HX-PRO headroom extension system.

BLOCK DIAGRAM

DR-M33HX

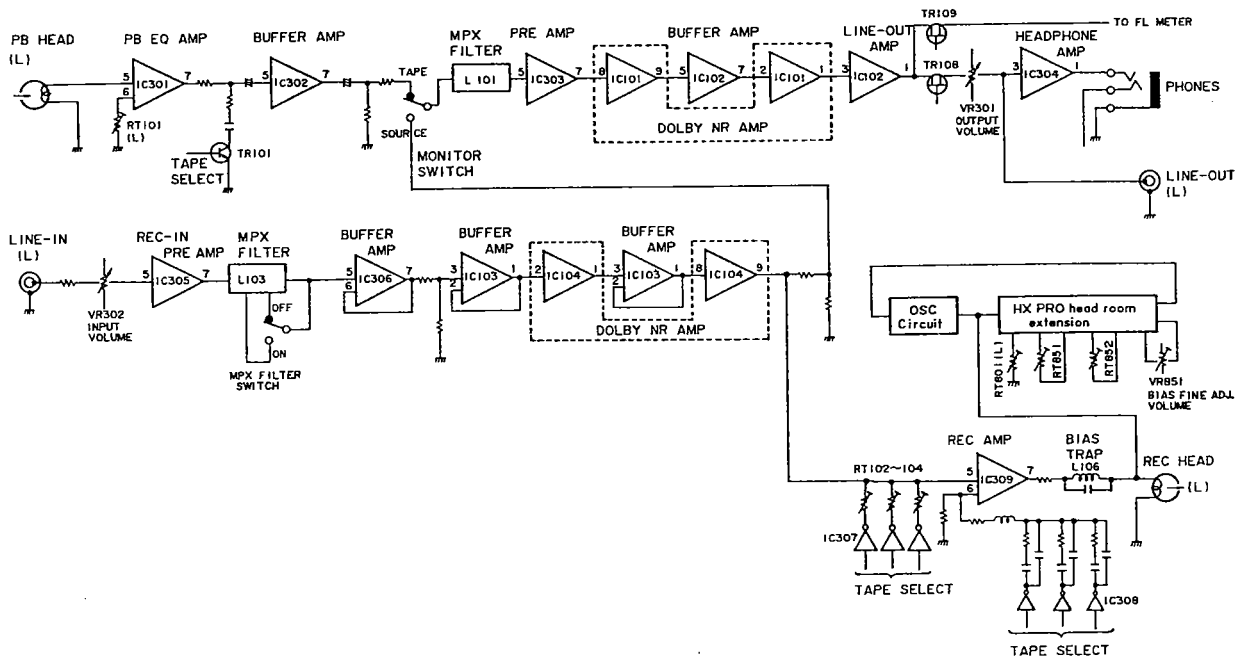

DR-M44HX

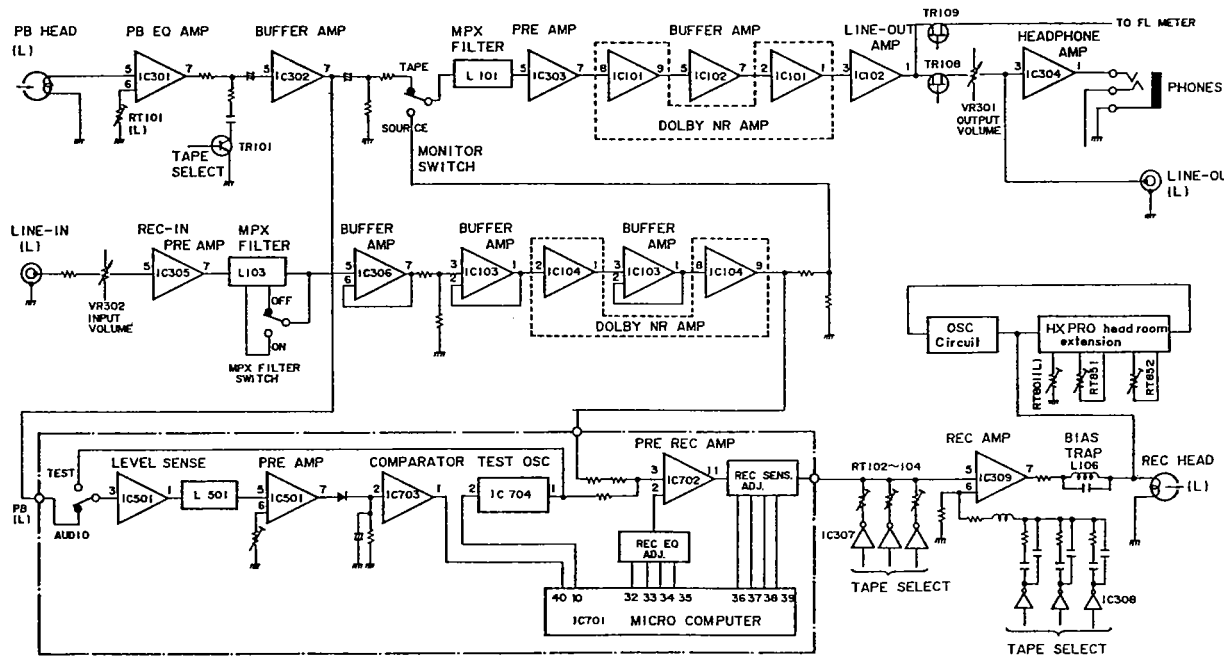

LEVEL DIAGRAM

PLAYBACK SYSTEM

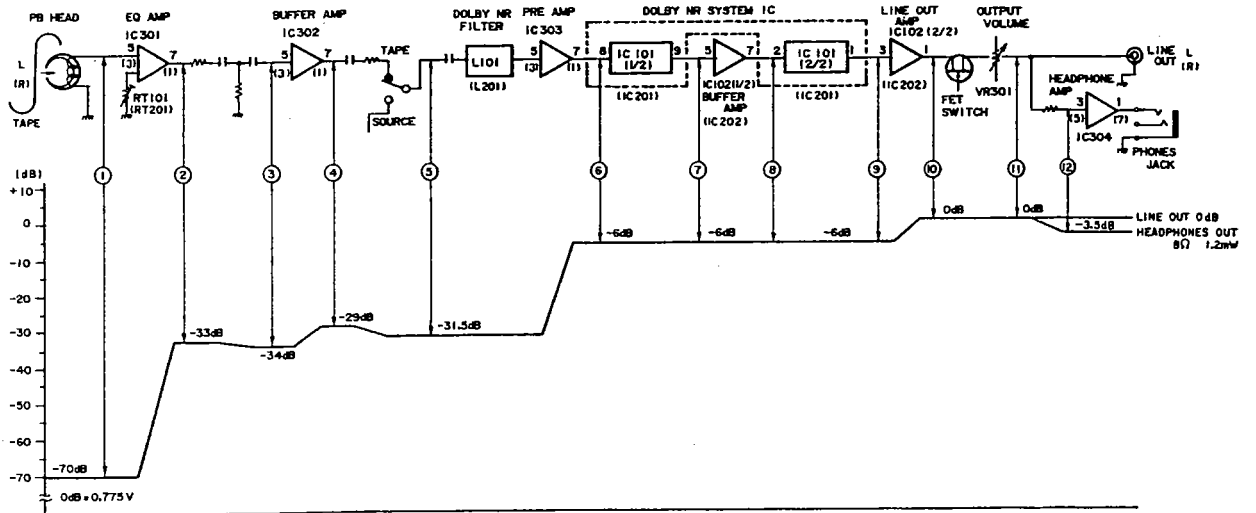

RECORDING SYSTEM

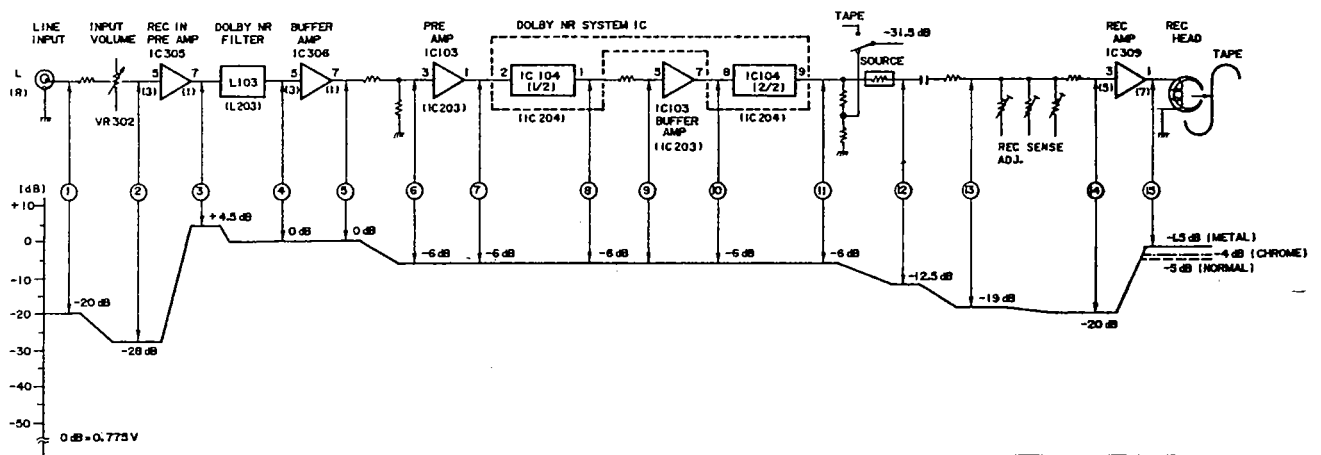

• **Outline of the Mechanism Control Microcomputer**

The function of the microcomputer, which is applied to the uni-directional transport cam drive control cassette deck mechanism, will receive an outside signal from the operation switch (operations such as PLAY, REC, STOP, FF) during the recognition of the current condition or from the surrounding circuits of the microcomputer (automatic tuning, linear counter, cam encoder, reel pulse, etc.) and sends the appropriate control signal.

To the mechanism: rotational direction of the reel motor, speed, stop, rotational direction of the cam motor, stop.
 To the linear counter: makes an output of the mechanism run mode command (REW, FF, PAUSE, PLAY).

To the automatic tuning: REC, P/B, LINE mute signal commands. Makes an output of the BIAS ON/OFF command (CUE command).

To the display: REC, PAUSE (REC MUTE during flash). In addition, the following points are taken into consideration.

- (1) Stable and accurate cam rotation position control is required since a cam drive method is employed to make the mechanism silent. Accurate rotation position control is performed by using a cam drive with a rotary encoder detected digital feedback servo.
- (2) Since the leading time of the cam drive is slower when compared to that of the plunger method, problems will arise when attempting record/playback or stop at the designated tape position from FF or REW, since tape overrun occurs. This is especially important when controlling the recording from the position where the automatic tuning was completed.

(Erasing the previous music when making recordings after the automatic tuning is completed must be prevented.)

For this, the tape cuing is corrected after the automatic tuning is completed to control the tape position accurately.

- (3) Power outage measures

When the power supply is cut off, the cam of the mechanism shifts to the STOP.

- (4) Overload measures of the cam

If the cam stops due to an overload for any reason and cannot shift to the target position within 4 seconds, it is immediately shifted to STOP. If this cannot be shifted within 4 seconds, the microcomputer will stop all controls and stop the motor to prevent a breakdown.

• **Auto Tuning (CTS)**

This tuning system automatically sets the equalizer and recording sensitivity, both of which are important to maximizing the performance of various tapes and to make high quality recordings. The tuning time is only 6 seconds; recording chances are not missed. When the cassette is loaded, the auto tape selector sets the deck to the standard optimum condition. Strictly speaking, however, the recording sensitivity and frequency characteristics of the tapes vary, depending on its type.

The auto tuning system allows the maximum performance of the tape to be heard and at the same time ideally corrects the frequency characteristics to a flat and wide range characteristic.

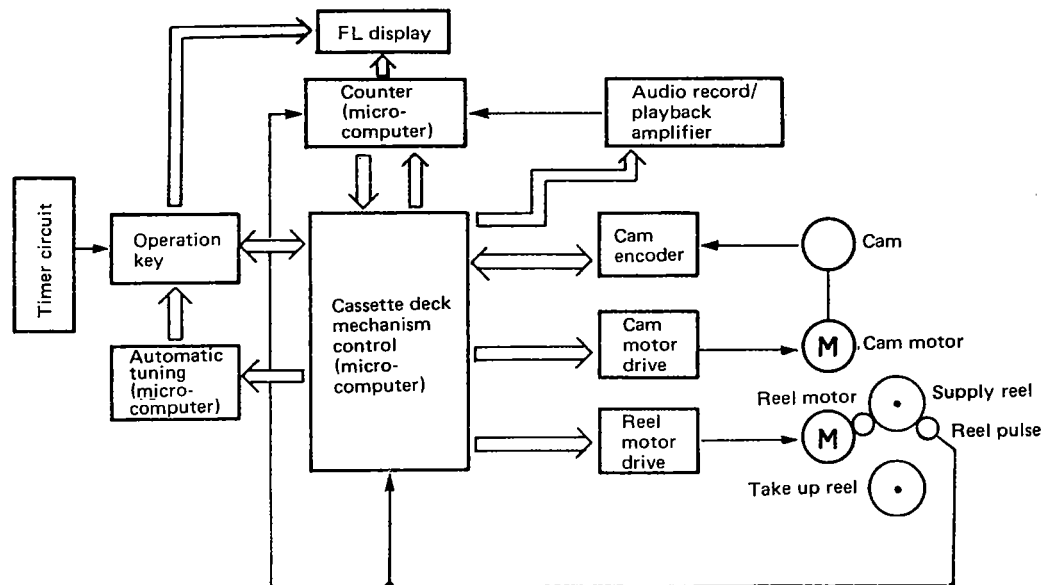

DISASSEMBLY INSTRUCTIONS

1. How to Remove the Front Panel

- (1) Unscrew the 4 screws 309 from both sides of the top cover 240 and take off the top cover by pulling it up.
- (2) Press the eject knob 231, open the cassette window 239 and take off the mechanism, as shown in the diagram.

Note: Be careful when handling the cassette window, as it is easily scratched.)

- (3) Remove the connector (5P) with lead wires, which runs from the timer switch 234 to the rear of the logic circuit board 202, from the logic circuit board.
- (4) The front panel can be removed by unscrewing the 3 upper screws (3x8 CFTS S tight) 307 from the front panel 233 and the 3 lower screws (3x8 CBTS P tight) 308.

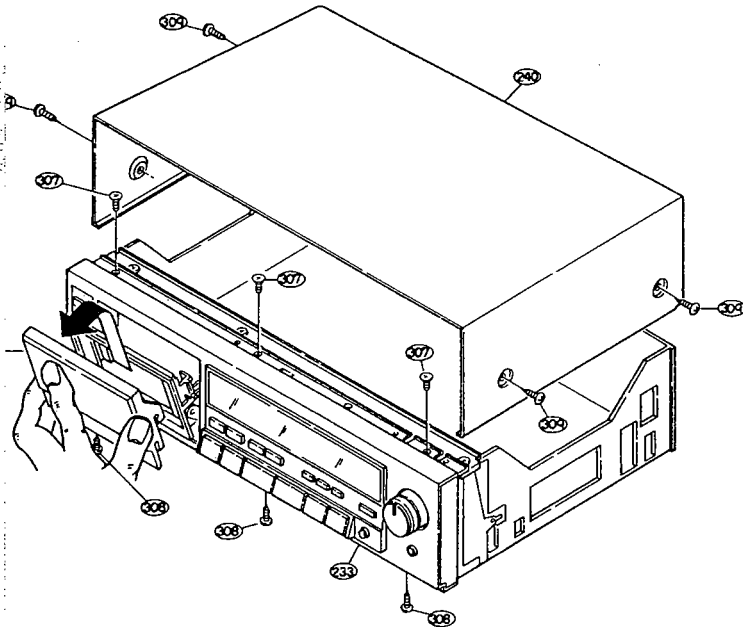

2. How to Remove the Mechanisms

- (1) Remove the top cover 240 and the front panel 233. (Refer to section 1)
- (2) Unscrew the 2 mechanism holding screws (3x6 CBTS S tight) 304 from the bottom surface of the chassis 201.
- (3) Unscrew the 2 screws (3x6 CBTS S tight) 304 holding the angle 210 and the mechanism 207 and the 3 chassis holding screws 301, 310 and remove the angle.
- (4) Remove the connectors with lead wires, which runs from the mechanism section, from the circuit board.

Audio circuit board side 2P connector CN101 CN201
3P connector CN303

Logic circuit board side 2P connector CN2 CN3
4P connector CN9 CN13 (DR-M44HX only)
5P connector CN10
6P connector CN9 (DR-M33-HX only) CN11
HX PRO circuit board side
3P connector CN801
4P connector CN802

Note: When assembling, check to make sure the connectors are inserted correctly.

- (5) Pull out the power switch lever 230 from the power switch 259.
- (6) Remove the eject knob 231.
- (7) The mechanism can be removed by holding the mechanism and pulling up.

Note: When assembling, do so after checking to make sure the 2 stay holes on the lower side of the mechanism unit are matched with the chassis protrusions.

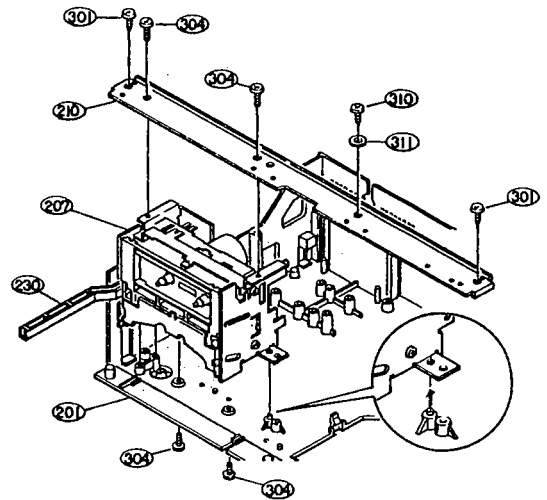

3. Removal of Front Escutcheon, Meter Window, and Control Button

- (1) Remove Top Cover (240) and Front Panel (233). (Refer to Section 1)
- (2) Unscrew the 3 screws (3 x 8 CBTS P Tight) (301) which secure Front Escutcheon.
- (3) Front Escutcheon (221) is fixed to the Front Chassis (206) by 3 pins; located at right, left, and below, so that Front Escutcheon may be removed when these pins are removed in order of right, below and left as indicated by arrow.
- (4) Meter Window (220) may be removed after Front Escutcheon is removed.
- (5) Control Button (223) should be removed after the 4 screws (306) (2.6 x 8 CBTS P Tight) are removed which secure the Press Bar (224).

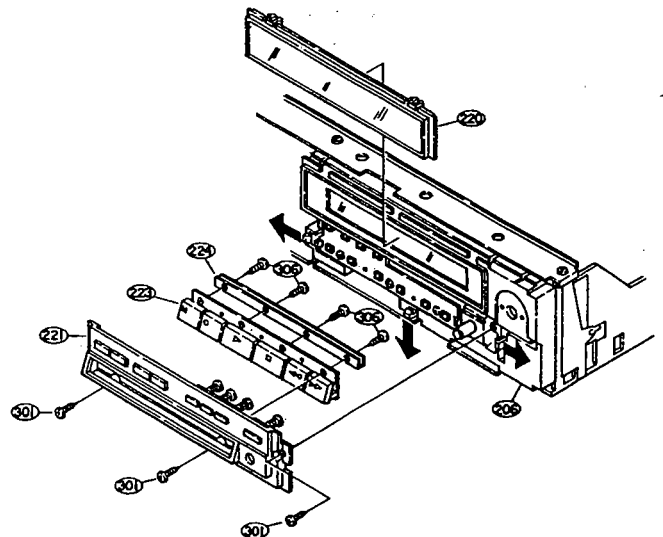

4. How to Remove the Control Circuit Board

- (1) Remove the top cover 240 and the front panel 233 (Refer to section 1)
- (2) Remove the front escuchion 221. (Refer to section 3)
- (3) Remove the connectors with lead wires which run from the control circuit board 204.

FL counter circuit board side	5P connector CN404
Logic circuit board side	8P connector CN4
CTS circuit board side	4P connector CN701 CN704
- (4) By unscrewing 3 screw (3x8 CBTS P tight) 301 holding the control circuit board and loosening the 3 hooks on the control circuit board 204 can be removed.

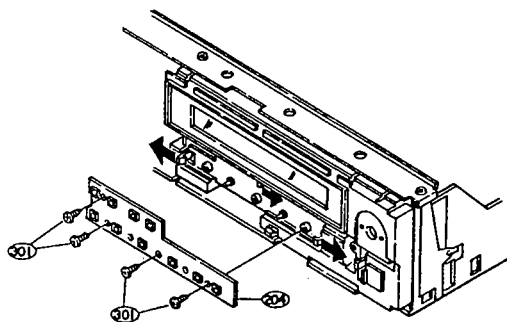

Note: When replacing the tact switch 257, always check to make sure that it is not floating above the circuit board. If it is floating, the switch will be in the on condition when the set is assembled.



5. How to Remove the FL Meter

- (1) Remove the top cover 240 (Refer to section 1)
- (2) Remove the connectors on the FL meter circuit board 205.
- (3) Remove the 2 screws (307) (3 x 8 CFTS S Tight) which secure FL Meter, Screw (310) (3 x 10 CBS), and washer (3W). Then the FL Meter may be removed.

CAUTION:

During assembly, avoid snagging the Shield Sheet (243), which is located under the Counter/Meter Circuit board (205), on the FL Meter.

6. How to Remove the CTS Circuit Board (DR-M44HX only)

- (1) Remove the top cover 240 (Refer to section 1)
- (2) Remove the 4P connectors from the CTS circuit board 217.
- (3) The CTS circuit board 217 can be removed upwards by pulling it upwards and loosening the 2 hooks on the chassis 201.

7. How to Remove the Audio Circuit Board

- (1) Remove the top cover 240 and the front panel 233. (Refer to section 1)
- (2) Remove the angle ~~210~~ (Refer to section 2)
- (3) Remove the front escuchion 221 and the meter window 220. (Refer to section 3)
- (4) Remove the control circuit board 204, and the FL meter 256. (Refer to sections 4, 5)
- (5) Remove the CTS circuit board 217. (Refer to section 6)
- (6) Remove the connectors from the audio circuit board 203.
- (7) Unscrew the 4 bottom cover holding screws (3x8 CBTS P tight) 308 on the back side of the chassis 201 and remove the bottom cover 218.
- (8) Unscrew the screw 301 holding the Audio amp circuit board.
- (9) By lifting the front chassis 206 and loosening the 2 hooks on the chassis holding the audio circuit board 203, the audio circuit board can be removed.

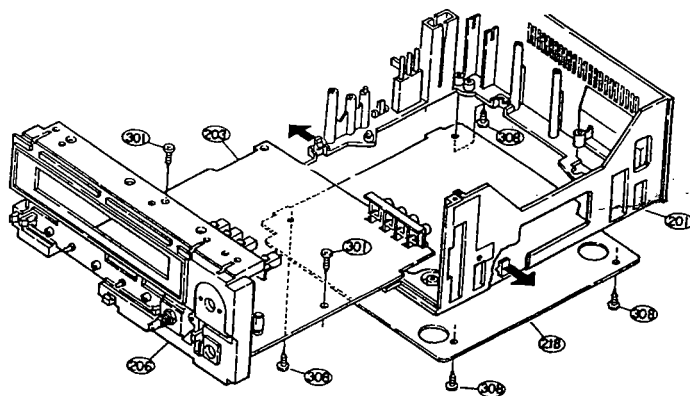

When Separating the Audio Circuit Board by Itself

- (10) Unscrew the nut holding the input volume 253 and remove the input volume and the shield bracket 209 toward the rear.
- (11) Unscrew the nut holding the output volume 254.
- (12) Remove the spring plate holding the hedephone jack 255.
- (13) By removing front chassis 206, the audio circuit board can be removed by itself.

Note: Most repairs to the audio circuit board can be performed by removing the bottom cover on the chassis. Refer to the above procedure only when necessary.

When reassembling, follow the procedures in reverse order; however, if each of the various parts are not assembled properly in their respective position, the set cannot be assembled. When assembling, check the work of each step carefully.

8. How to Remove the Logic Circuit Board

- (1) Remove the top cover 240. (Refer to section 1)
- (2) Remove the CTS circuit board 217. (Refer to section 6)
- (3) Remove the various connectors from the logic circuit board 202.
- (4) Unscrew the 2 screws (3x8 CBTS P tight) 301 holding the logic circuit board.
- (5) Unscrew the screw (3x10 CBTS P tight) 302 holding the P.W.B support 241.
- (6) Pull the logic circuit board 202 forward until the DIN jack 240 is disconnected from the rear of the chassis 201; it can then be removed.

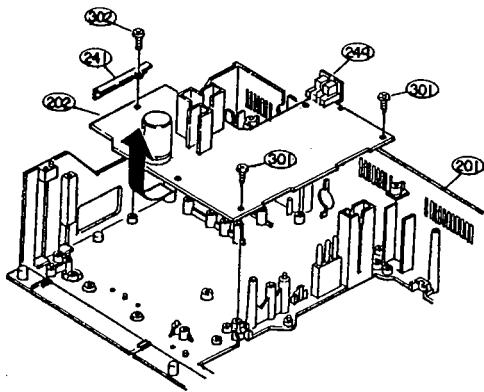

9. How to Remove the HX PRO circuit Board

- (1) Remove the top cover 240.
- (2) Remove the connectors from the HX PRO circuit board 262.
- (3) Remove the 2 screws (301) which secure HX PRO circuit board. Then the HX PRO circuit board may be removed.

10. How to Remove the Power Supply Circuit Board

- (1) Remove the top cover 240. (Refer to section 1)
- (2) Unscrew the 1 screw (3x8 CBTS P tight) 301 holding the bracket 216 of the power supply circuit board 215.
- (3) By pulling the power switch lever 230 out of the power supply switch, the power supply circuit board can be removed upwards.

ADJUSTING AND CHECKING THE MECHANISM SECTION

1. Replacing the Pinch Roller 23 and 104

Before replacing the pinch roller, clean the tape contact surface of the pinch roller and the capstan shaft.

Most causes of poor tape transport can be traced to dirty pinch rollers and capstan shafts.

The right side pinch roller 23 can be taken out by removing spring 24 and slit washer 317. In the same manner, the left side pinch roller 104 can be taken out by removing spring 106 and SPECIAL NUT 100. After replacing, play a padless C-90 tape and check for tape curls at the head tape guide section.

In addition, in the playback mode, check to make sure that the right side pinch roller contacts the capstan shaft before the left side pinch roller contacting.

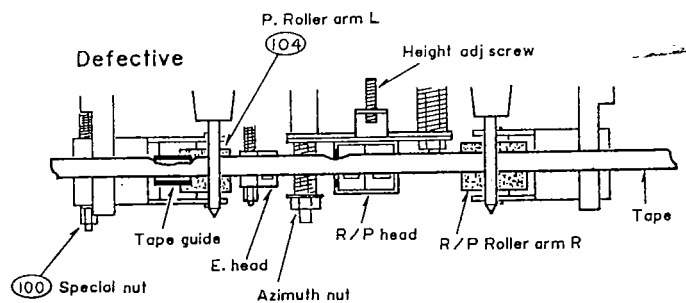
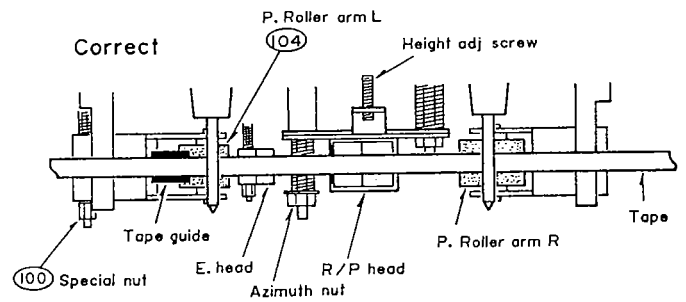

2. Checking the Pressure Force of the Pinch Roller

In the playback mode, hook a spring weight onto the bracket at the center of the pinch roller. After separating the pinch roller from the capstan shaft, allow the pinch roller to contact the capstan shaft again. When the pinch roller starts to rotate, check to make sure the rod type spring weight reading is 350g–450g for the right side and 150g ~ 250g for the left side.

If it is not within the normal range, replace the pinch roller spring 24 or 106.

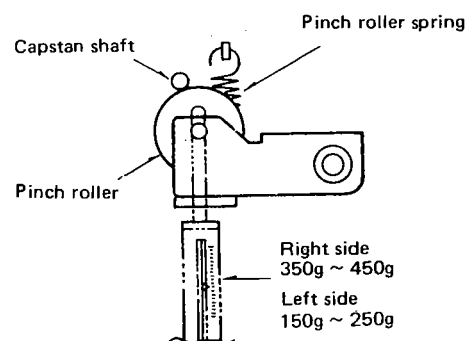

3. Replacing the Record/Playback Head

* Before replacing, remove the front panel 202.

(1) How to remove the R/P HEAD.

- 1) Next, Take out the azimuth adjustment NUT 311, screw 322, and the SPECIAL NUT 311 loosening them alternately.

If they are not loosened alternately, the R/P HEAD base may become warped.

- 2) By unsoldering the HEAD WIRES on the circuit board section of the R/P HEAD, the entire R/P HEAD can be taken off the mechanism unit.

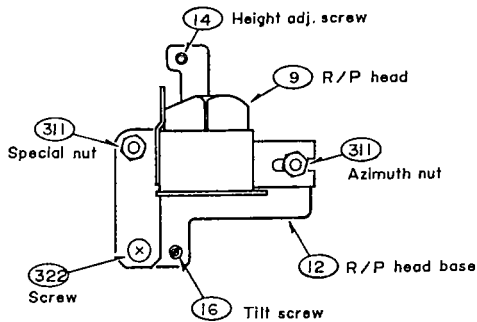

(2) How to assemble the R/P HEAD.

Reverse the above (1) procedures for removing the R/P HEAD.

* Solder the HEAD WIRES according to the diagram above.

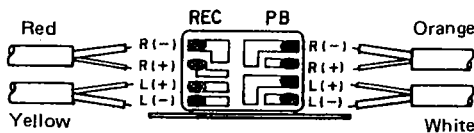

4. Adjusting the R/P HEAD

(1) Height adjustments (Use the head adjusting jig M-300)

- 1) Set the M-300 tool plate on the mechanism unit; turn the height adjustment SCREW 14 and adjust so that the 3.8 mm measure section of the M-300 (tool grip) can pass without contacting the tape guide of the R/P HEAD 9.

- 2) When adjusting the height, make sure the R/P HEAD is not tilted by turning the azimuth adjustment nut 311 nut, and checking with your eyes.

* Never allow the M-300 (tool grip) to hit the tape contact surface of the R/P HEAD strongly. It may scratch the surface.

(2) Adjusting Tilt Angle

- 1) Set the M-300 Tool Plate on the Mechanism Unit and then place the M-300 Tool Grip on the R/P Head, and check the Tilt Angle between M-300 Tool Plate and M-300 Tool Grip. If the M-300 Tool Grip is tilting toward the rear, loosen Tilt with screw (16). If the M-300 (Tool Grip) is tilting toward the front, tighten it. Adjust the Tilt screw (16) until the M-300 Tool Grip becomes parallel with the M-300 Tool Plate.
- 2) If the Tilt Angle is adjusted more than once, height Adjustment may slip. Always make sure to check height adjustment. If height has slipped, adjust it again. After adjustment, fix screw.

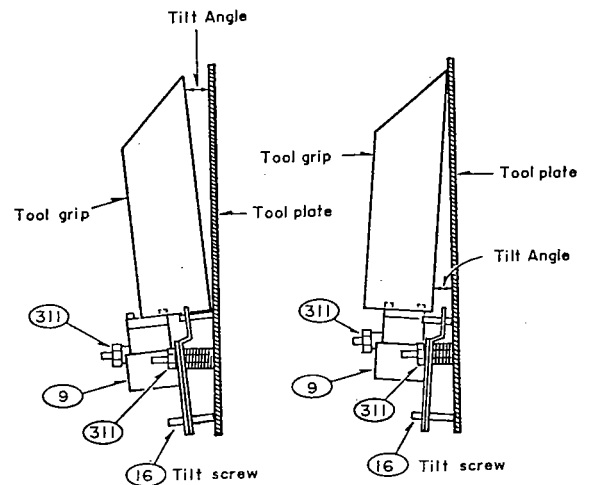

(3) Azimuth adjustments

Play back the MTT-114 test tape. Turn the azimuth adjustment nut and adjust so that A of the resurge wave form is maximum and B is minimum. After the azimuth adjustments, re-check the head height with the M-300 to make sure the height has not deviated.

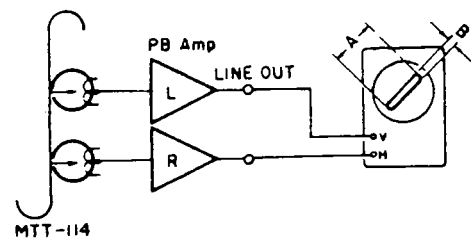

* After the adjustments, apply anaerobic adhesive on the positions indicated in the diagram.

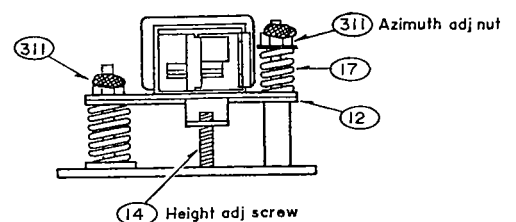

5. Adjustment and Replacement of Erasing Head (15)

(1) Height Adjustments

Set the M-300 Tool Plate on the mechanism unit. Using a surface measure of 3.8 mm from the M-300 Tool Grip, turn nut (311) and (171) and adjust the height of Erasing Head's center to coincide with the center of the M-300 Tool Grip. After adjustment, place the M-300 Tool Grip on the Erasing Head, check to see that the M-300 Tool Plate and the M-300 Tool Grip are parallel, and that the Tilt Angle has not changed. Lock after adjustment.

(2) Tilt Angle Adjustment

Set the M-300 Tool Plate on the mechanism unit. Place the M-300 Tool Grip on the Erasing Head, and check the gap between the M-300 Tool Plate and the Tool Grip. If the M-300 Tool Grip is tilting toward the front, loosen the Tilt NUT (311). If it is tilting toward the rear, tighten it and adjust the Tilt NUT (311) until the M-300 Tool Grip becomes parallel with the M-300 Tool Plate.

CAUTION: After adjusting the Tilt Angle, height adjustment may sometimes be warped. Recheck height adjustment. If it is warped, readjust the height. After adjusting, fix nut (311) and (171).

(3) Erasing Head Replacement

Erasing Head may be replaced after removing nut (311) and (171) which affix it to the deck mechanism. After replacement, adjust the height and the Tilt angle.

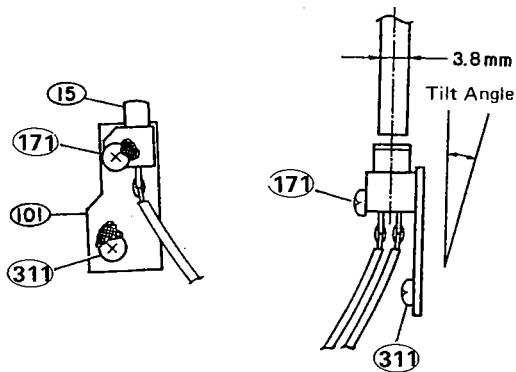

6. Height Adjustment of the Tape Guide 103

Set the M-300 jig plate onto the mechanism unit and adjust the height by rotating the height adjustment nut 100 so that the 3.8mm section of the M-300 jig can pass through without contacting the tape guide section of tape guide 103.

7. Thrust Play Check and Adjustments of the Capstan Shaft

Thrust Play check and Adjustments of the Capstan Shaft 45, 111. From the front of the mechanism, grasp the capstan shaft and move back and forth in the axis direction. Check to make sure there are thrust play in the right side capstan shaft 45. Rotate and adjust capstan support 110 so that the range of the thrust play of the left side capstan shaft 111 is within 0.2mm—0.4mm. After adjusting, apply anaerobic adhesive to the capstan support 110.

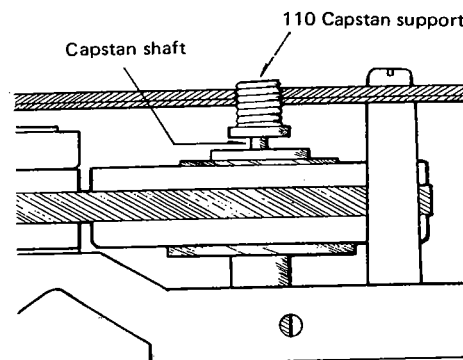

8. Checking the Take-up Torque

Load the cassette type torque meter. Check to make sure that the torque meter average reading is within 50 ~ 100 g-cm during playback. If it is not within this range, check the voltage ($3.5V \pm 0.3V$) of the reel motor. If the voltage is low, the torque will be weak; if it is high, the torque will be strong. In addition, check for reel thrust movement in section 9.

9. Adjusting the Reel Thrust Movement

Check to make sure that the reel thrust movement is within 0.2—0.4 mm.

10. Checking the FF and REW Torques

* When using the cassette type torque meter.

Check to make sure the torque meter indicates more than 70 g-cm at the end of FF and REW.

* When using a modified cassette half.

Load the modified cassette half; hook the end of the dial tension meter (full scale 100—300 g) onto the triangle section. In the FF (REW) mode, feed the tape in at a rate somewhat slower than the take up speed. Check to make sure the dial tension meter reads more than 60 g-cm.

11. Checking the Back Tension Torque During Record/Playback

Load the cassette type torque meter; check to make sure the torque meter reads between 7 ~ 13 g-cm during playback and that there is no unevenness.

If it is not within this range, check the section on adjusting the reel thrust movement; or replace the spring 109.

12. Checking the FF and REW Times

Load a C-60 cassette tape; check to make sure the tape is fast forwarded or rewound within 70–110 seconds. If it is not within this range, check sections 9 and 11.

13. Checking the Operation of the Erase Prevention, Metal and Chrome Switch Operation Arms

Check to make sure the operation arms 58, 59 operate the switches positively, depending on whether or not there are holes.

14. Checking the EJECT Switch 75

To check the operation of the EJECT SW with only the mechanism unit, make sure the angle 205 operates the switch positively when the hook lever 203 is operated.

15. Checking the Gap Between the Pulse Detection LED and the Reel Ass'y

Check to make sure the gap between the surface of the shutter section of the reel ass'y and the LEDs is approximately 1 mm.

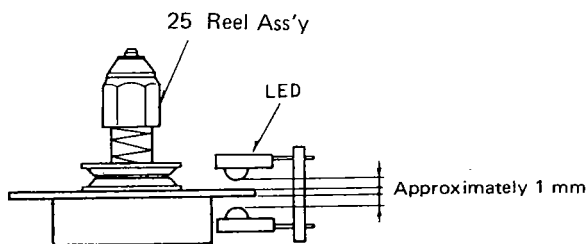

ADJUSTING THE ELECTRICAL SECTIONS

● Measuring instruments necessary for adjustments

- (1) Audio signal generator
- (2) Variable resistance attenuator
- (3) Vacuum tube voltmeter
- (4) Oscilloscope
- (5) Frequency counter
- (6) Adjustment screwdriver
- (7) Trap coil adjustment square stick
- (8) Test tapes (MTT-111, MTT-114, MTT-150)
(TCC-262)
(DENON DX3H, DXM, HD7E, LX)
- (9) Transport Check cassette tape (MC-112C)

● Cautions on adjusting

- (1) Before adjusting, clean the head surface, capstan and the pinch roller with a gauze or a cotton swab moistened with alcohol.
- (2) Demagnetize the R/P HEAD and the E. HEAD with a head eraser.
- (3) Completely demagnetize the adjustment screwdriver.
- (4) Unless instructed otherwise, set the various controls as follows:
 - INPUT volume maximum
 - OUTPUT LEVEL volume maximum
 - DOLBY NR switch OFF
 - MONITOR switch TAPE
 - BIAS FINE ADJ. Volume (DR-M33HX) . . . Center

1. Tape Transport Check

Load the transport check cassette (MC-112C). In the operational mode, illuminate the fixing guides of the R/P HEAD with a lamp and check to make sure the tape edge does not come in contact with the tape guide section.

The tape transport is the most important element in determining the performance of a cassette deck.

Avoid moving the various adjustment screws, nuts, etc., as much as possible. Refer to the pages on "Adjusting and Checking the Mechanism Section" when replacing or adjusting the R/P HEAD.

2. Adjusting the Azimuth

- (1) After completing the tape transport check load the test tape (MTT-114).
- (2) Play back the test tape; adjust the azimuth screw so that section A of the resurge wave form is maximum and section B is minimum.

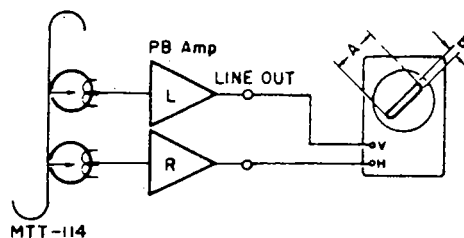

3. Checking and Adjusting the Tape Speed

- (1) Connect the frequency counter to the LINE OUT terminal and load the test tape (MTT-111).
DR-M44HX
- (2) Play back the test tape; at the midpoint of the tape, where the transport is stable, adjust VR 901 so that the frequency counter reading is in the range of 3,000 Hz \pm 6Hz.
DR-M33HX
- (3) Playback a test tape. At about halfway through the tape, where the tape transport is stable, adjust the adjustment points on the back of the capstan motor so that the frequency counter will have a reading within the range of 3,000 Hz \pm 6Hz.

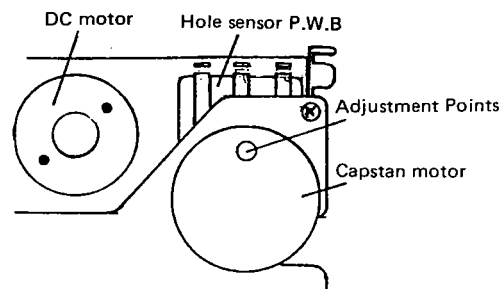
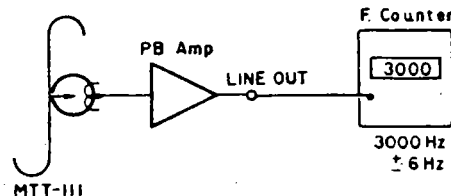

4. Checking the Input Sensitivity

- (1) Set the MONITOR switch to SOURCE position, the operational mode at STOP. Supply a 400 Hz signal to the LINE IN terminal and set the input signal level (approx. -20 dB) so that the output level at the LINE OUT TERMINAL (L ch) becomes 0dB.
- (2) At the same time, check to make sure the R ch output level is also 0dB.

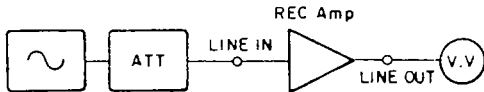

5. Checking the Operation of the DOLBY

Set the MONITOR switch to SOURCE. When a -41dB signal input is made to the LINE IN terminal, check to make sure the output frequency response from the LINE OUT terminal meets the specification in the diagram below.

Dolby C Back to Back Frequency Response

Level: -20dB from Dolby
Monitor: Source
Dolby NR: on, C

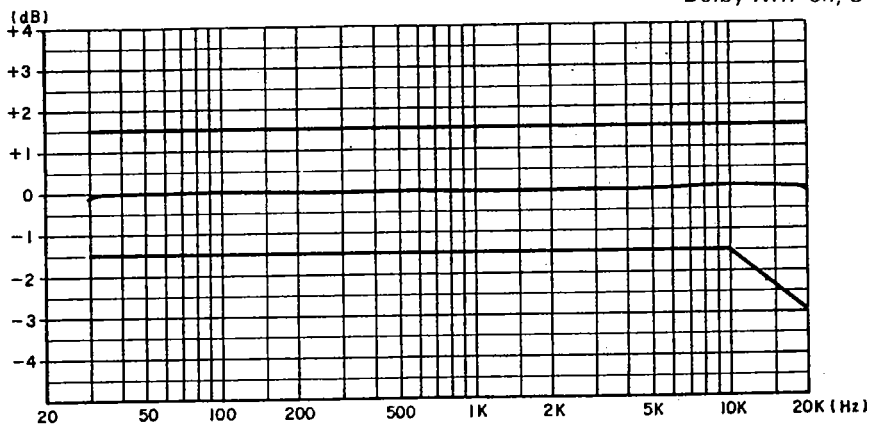

6. Adjusting the Playback Section

- (1) Adjusting the playback level
Play back the Dolby standard level test tape (MTT-150) and adjust RT 101 (L ch), RT 201 (R ch) so that the LINE OUT voltage becomes 0 dB (0.775V).
- (2) Adjusting the playback frequency response
Play back the test tape (TCC-262) and check to make sure that the frequency response meets the specifications in the diagram.

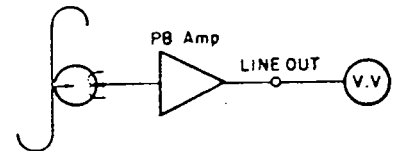

Tape: TCC-262

When using MTT-316 make corrections along.

Playback Frequency Response

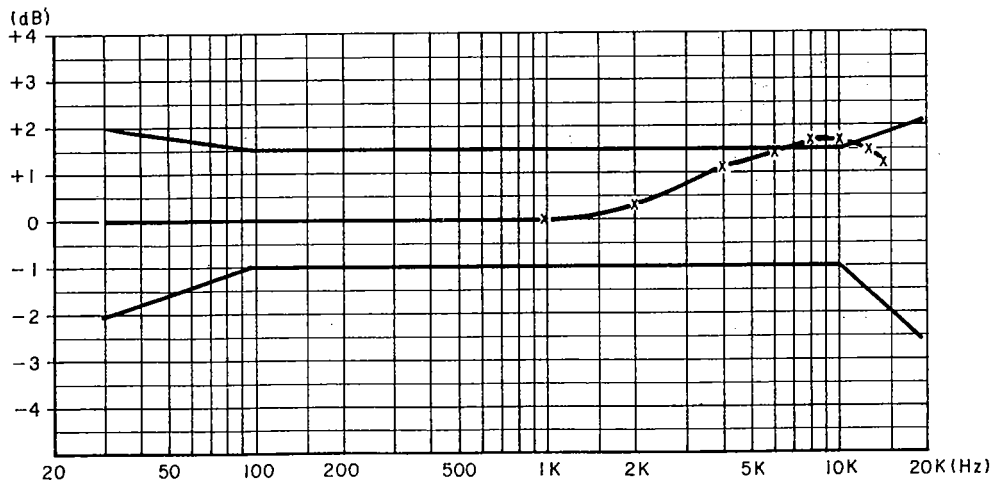

7. Adjusting the FL Meter

After adjusting the playback level, playback the test tape (TEAC MTT-150) and adjust RT401 (L ch), RT402 (R ch) so that the FL meter indicates 0dB when the LINE OUT terminal level is 0dB (0.775V).

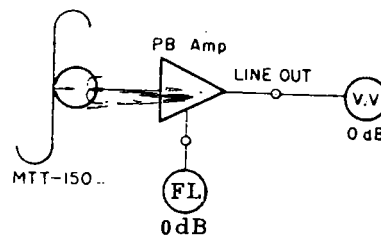

8. Adjusting the Recording Section

(1) Adjusting the record/playback overall frequency response.

- 1) Load the test tape HD7E; record a signal with an input level of -41 dB, 1 kHz at the LINE IN terminal; play back this recording.
- 2) Change the frequency of the input signal to 12 kHz, record and playback; adjust RT801 (L ch), RT802 (R ch) so that the output level is about equal compared to the 1 kHz signal output level.
- 3) Load the test tape DXM; record a signal with an input level of -41 dB, 1 kHz at the LINE IN terminal; Play back this recording.
- 4) Change the frequency of the input signal to 12 kHz, record and playback; adjust RT852 so that the 12 kHz signal output level goes within the limits of $0 \text{ dB} \pm 2 \text{ dB}$ when compared to the 1 kHz signal output level.
- 5) Load the tape DX3H; record a signal with an input level of -41 dB, 1 kHz at the LINE IN terminal; Play back this recording.
- 6) Change the frequency of the input signal to 12 kHz, record and playback; adjust RT851 so that the 12 kHz signal output level goes within the limits of $0 \text{ dB} \pm 2 \text{ dB}$ when compared to the 1 kHz signal output level.
- 7) Check to make sure that the overall frequency response meets the following diagram.

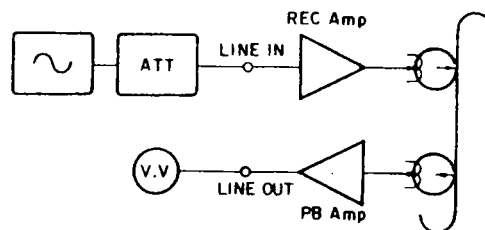

Record/Playback Overall Frequency Response

Tape: HD7E Dolby: off
Level: -20 dB from Dolby.

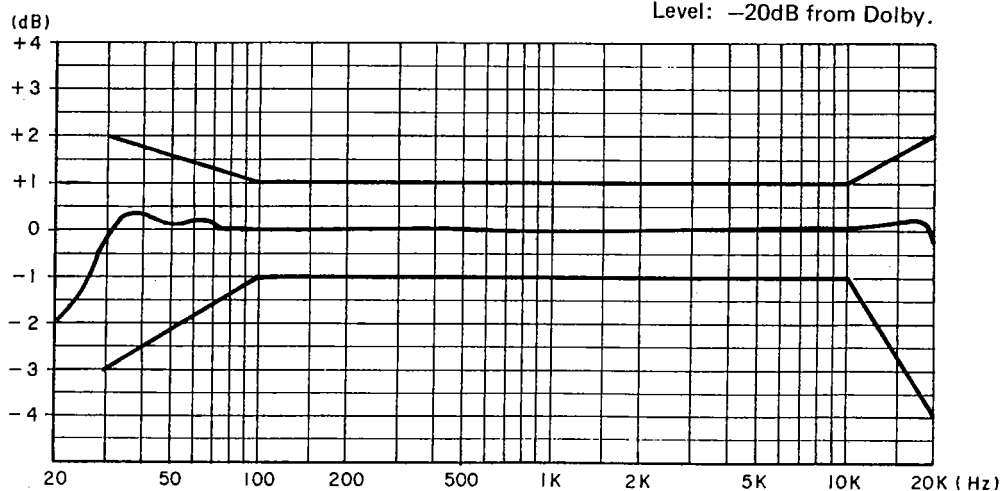

(2) Adjusting the record/playback levels

- 1) Load the test tape DX7/50N and record a signal of 1kHz (-41 dB).
- 2) Adjust RT103 (L ch), RT203 (R ch) so that the output level is the same when the MONITOR switch is switched from SOURCE to TAPE position.
- 3) Load the test tape and record a signal of 1kHz (-41 dB).
- 4) Adjust RT 102 (L ch), RT 202 (R ch) so that the output level is the same when the MONITOR switch is switched from SOURCE to TAPE position.
- 5) Load the test tape DX3 and record a signal of 1kHz (-41 dB).
- 6) Adjust RT104 (L ch), RT 204 (R ch) so that the output level is the same when the MONITOR switch is switched from SOURCE to TAPE position.

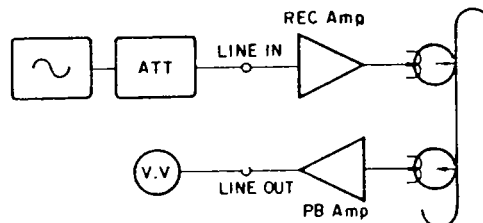

(3) Checking the Dolby C record/playback overall frequency response

- 1) Set the DOLBY NR switch to the "C" position.
- 2) Using the test tapes DXM, DX7/50N, DX-3, perform record/playback in the same manner as 8-(1).
- 3) Check to make sure that the record/playback overall frequency response meets the specifications in the diagram.

Dolby C Record/Playback Overall Frequency Response.

Tape: DX7N
 Dolby: on, C
 Level: -20dB from Dolby

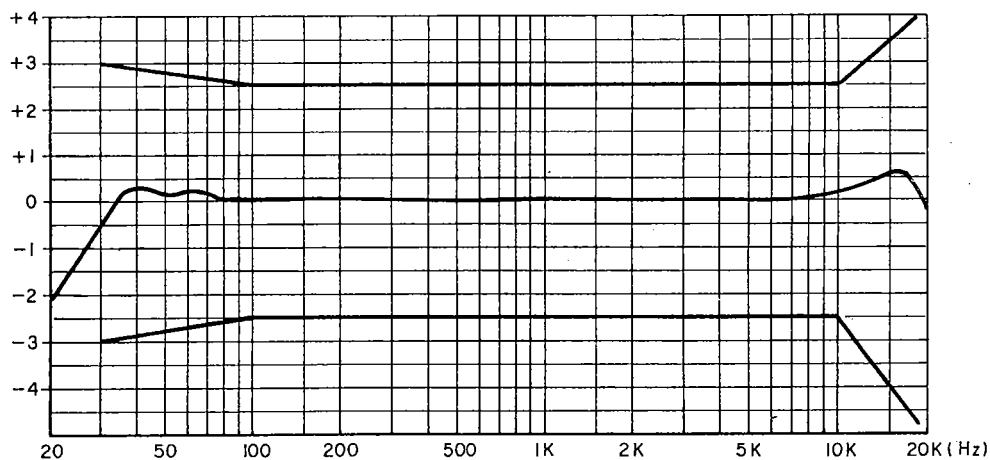

9. Adjusting the CTS

(1) Adjusting the CTS Amplifier Gain

- 1) Load the test tape HD7E.
 - 2) Connect the oscilloscope to the test point TP(L) of the CTS circuit board.

Set the switch S701 to the TEST side and press the CTS START button.

During its operation, adjust VR501 (L ch) so that the DC level at TP(L) alternate frequently between H → L or L → H.
 - 3) Connect the oscilloscope to the test point TP(R) of the CTS circuit board and press the CTS START button.

During its operation, adjust VR601 (R ch) so that the DC level at TP(R) alternate frequently between H → L or L → H.
 - 4) Set the switch S701 to the AUDIO side.

(2) Checking the CTS Operation

- 1) Load the LX cassette tape. Light the preset lamp and set to the preset mode. Record/playback 1kHz and 12kHz signals and note the frequency response.
- 2) Press the CTS START button. After it is completed, (CTS lamp lit), record/playback the 1kHz signals and check to make sure the frequency response is improved over those recorded in section 1).

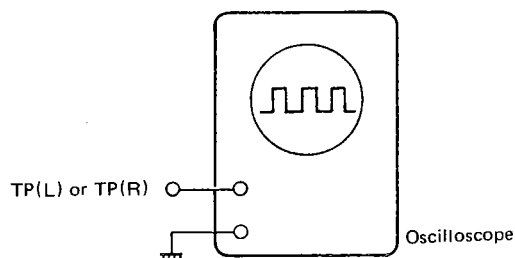

PARTS LIST OF P.W. BOARD

KU-5610/5611 AUDIO AMP UNIT

Ref. No.	Part No.	Part Name	Remarks
SEMICONDUCTOR GROUP			
IC101,104 201,204	2630311002	NE651	
IC102,103 203,203 302~306 309	2630189001	M5218L	
IC301	2630226003	M5220L	
IC307,308	2620290007	HD74LS05P	
TR101~107 110~115 201~207 210~215 301,304	2730178022	2SC1740 (S)/(R)	
TR302	2710101006	2SA933 (R)	
TR303	2730195005	2SC2060 (Q)	
TR108,109 208,209	2750043014	2SK381 (C)/(D)	
D301~308	2760049008	IS2076	
RESISTOR GROUP			
VR301	2118076005	V1620V—103KA	OUTPUT VR 10KΩA
VR302	2118075006	V1611V—503KA	INPUT VR 50KΩA
RT101,201	2116000099	V08PB202	PB GAIN 2KΩB
RT103,104 203,204	2116000073	V08PB203	NOR REC CAL 20KΩB
RT102,202	2116000044	V08PB503	ME REC CAL 50KΩB
CAPACITOR GROUP			
C101,102 201,202	2533627000	CC45SL1H101J	Ceramic 100PF 50V
C122,222	2533633007	CC45SL1H181J	180PF 50V
C146,246	2531062007	CK45B1H392K	0.0039μF 50V
C155,255	2531003008	CK45B1H681K	680PF 50V
C148,248	2531004007	CK45B1H102K	
C153,253	2531008003	CK45B1H472K	0.0047μF 50V
C121,131 151,221 233,251	2539031014	CK45=1E683K	0.068μF 25V
C315~317	2531024003	CK45F1H103Z	0.01μF 50V Electrolytic
C109,118 130,137 209,218 230,237	2549014005	CE04W1HOR1M	0.1μF 50V
C117,129 217,229	2549014034	CE04W1HR15M	0.15μF 50V
C156,256	2544146004	CE04W1H010=	1μF 50V
C157,257 307	2544132005	CE04W1C100=	10μF 16V
C310,311	2544140000	CE04W1V4R7=	4.7μF 35V
C309	2544146004	CE04W1H010=	1μF 50V

Ref No.	Part No.	Part Name	Remarks
C125,225	2544140000	CE04W1V4R7=	4.7μF 35V
C106~108 116,123 124,128 136, 140~142 206~208 216,223 224,228 236, 240~242 303~306	2544132005	CE04W1C100=	10μF 16V
C103,150 203,250 301,302 C308	2544129005	CE04W1A470=	47μF 10V
C154,254 C147,247 C113,114 127,134 213,214 227,234 C104,144 145,149 204,244 245,249	2544131006	CE04W1A221=	220μF 10V Film
C154,254	2551120026	CQ93M1H152J	0.0015μF 50V
C147,247	2551120068	CQ93M1H332J	0.0033μF 50V
C113,114 127,134 213,214 227,234	2551120084	CQ93M1H472J	0.0047μF 50V
C104,144 145,149 204,244 245,249	2551120097	CQ93M1H562J	0.0056μF 50V
C105,205	2551121012	CQ93M1H822J	0.0082μF 50V
C112,135 212,235	2551121025	CQ93M1H103J	0.01μF 50V
C115,126 215,226	2551121083	CW93M1H333J	0.033μF 50V
C110,119 131,138 210,219 231,238	2551078000	CQ93M1H333K	0.033μF 50V
C120,132 220,232	2551122008	CQ93M1H473J	0.047μF 50V
C111,139 211,239	2561030025	CF93B2A224J	0.22μF 100V

• The carbon resistors rated at ¼W are not listed herein.

Ref. No.	Part No.	Part Name	Remarks
OTHER PARTS GROUP			
L101,201	4148205103	SHIELD CASE	
L102,104	2310825009	BIAS FILTER	
202,204	2358011008	INDUCTOR	
L103,203	2328043006	MPX FILTER	
L105,205	2358005056	INDUCTOR	(5.6 μ H)
L106,206	2328044005	BAND TRAP FILTER	
L301,302	2358005030	INDUCTOR	
S301	2129223009	PUSH SWITCH	
S302	2129224008	PUSH SWITCH	
J301	2048114008	4P PIN JACK	
J302	2048109013	HEADPHONE JACK	
CN101,201	2032075001	2P CONNE, BASE	
CN301	2035622024	4P MINI CONNE PIN	
CN302,303	2035622008	3P MINI CONNE PIN	
CN304	2035622079	7P MINI CONNE PIN	
CN305	2035691042	3P EI CON WITH WIRE	
CN306	2035691039	3P EI CON WITH WIRE	
CN307	2041640003	6P EI CON WITH WIRE	
CN308	2050170001	12P BOARD BASE	

• The carbon resistors rated at $\frac{1}{4}W$ are not listed herein.

KU-0451-1 CTS UNIT

Ref. No.	Part No.	Part Name	Remarks
SEMICONDUCTOR GROUP			
IC701	2620346003	HD44705A42	
IC703	2630161003	μ PC358C	
IC501	2630229000	LA6458DS	
601,702			
704			
TR501~511	2730178022	2SC1740 (S)/(R)	
601~611			
702~712			
D501,502	2760049008	IS2076	
601,602			
701			
D503,504	2760001004	IN34A	
603,604			
RESISTOR GROUP			
VR501,601	2116004024	V08QB202	2K Ω B
CAPACITOR GROUP			
C504,604	2531002009	CK45B1H471K	Ceramic 470PF 50V
C505,605	2531004007	CK45B1H102K	0.001 μ F 50V
C701,702	2531153000	CK99B1H102MP4	0.001 μ F 50V
			Electrolytic
C705~707	2544127007	CE04W0J221=	220 μ F 6.3V
C704	2544130007	CE04W1A101=	100 μ F 10V
C507,508	2544132005	CE04W1C100=	10 μ F 16V
512,607			
608,612			
C701,703	2544134003	CE04W1C330=	33 μ F 16V
C506,509	2544140000	CE04W1V4R7=	4.7 μ F 35V
606,609			
613,513			
			Film
C503,603	2551060005	CQ93M1H102K	0.001 μ F 50V
C610,611	2551062003	CQ93M1H152K	0.0015 μ F 50V
C502,602	2551063002	CQ93M1H182K	0.0018 μ F 50V
C501,601	2551066009	CQ93M1H332K	0.0033 μ F 50V
C510,511	2551074004	CQ93M1H153K	0.015 μ F 50V
C702	2551079009	CQ93M1H393K	0.039 μ F 50V
OTHER PARTS GROUP			
CN701,704	2035622024	4P MINI CONN. PIN	
CN702,703	2050171000	12P BASE CONTACT	
L501,601	2310825009	BIAS FILTER	
S701	2129190103	SLIDE SW	

• The carbon resistors rated at $\frac{1}{4}W$ are not listed herein.

KU-5211/5212 POWER AND LOGIC UNIT

Ref. No.	Part No.	Part Name	Remarks
SEMICONDUCTOR GROUP			
IC1,2	2620294003	HD74LS32P	
IC3	2620443003	HD74LS15P	
IC4	2620427003	HD74LS138P	
IC5	2620408006	UPD1511C-097	
IC6,7	2620447009	BA6109U1	
TR6,15 17~19,22	2710101006	2SA933 (R)	
TR2,12	2710105002	2SA966 (Y)	
TR7,11	2720055029	2SB772 Q/P	
TR5,8,9 13,14,16, 20,21 23~28	2730178022	2SC1740 (R/S)	
TR1	2730195005	2SC2060 (Q)	
TR3,4,10	2740078031	2SD882 (Q/P)	
D1	2760246005	RB152	
D2,7	2760057003	V06B	
D3~6	2760237001	RV06	
D8~12	2760049008	IS2076	
ZD1	2760249002	HZ18-2	
ZD2,5	2760303003	HZ6C-2	
ZD3,4	2760052053	HZ11B-1	
ZD6	2760220018	HZ24-1	
ZD7,14	2760299052	HZ3B-3	
ZD8	2760185027	HZ4B-2	
ZD9	2760185056	HZ4C-3	
ZD10	2760236073	HZ5B-1	
ZD13	2760218062	HZ-9A-1	
ZD12	2760218046	HZ9B-1	
RESISTOR GROUP			
R2	2442028017	RD14B2E330JFRF	33Ω ¼W
R48	2440079026	RS14B3D270JNBF	27Ω 2W
R17	2410163001	RD14B2H121J	120Ω 2W
RB1	2462018007	RK99=2B103MP6	10KΩx6 1/8W
RB2	2462011088	RK99=2B153MP3	15KΩx3 1/8W
RB3	2462010076	RK99=2B103MP4	10KΩx4 1/8W
RB4	2462010092	RK99=2B104MP4	100KΩx41/8W
CAPACITOR GROUP			
C30	2533627000	CC45SL1H101J	Ceramic 100PF 50V
C29	2533635005	CC45SL1H221J	220PF 50V
C36,38	2531024003	CK45F1H103Z	0.01μF 50V
C31~34	2531004007	CK45B1H102K	0.001μF 50V
C15, 21~26 40,41,45	2531024003	CK45F1H103Z	0.01μF 50V
C37,39	2531025002	CK45F1H223Z	0.022μF 50V
C27	2539014002	CK45=1E683M	0.068μF 25V
C44	2539012004	CK45=1E333M	0.033μF 25V
C99	2539015001	CK45=1E104M	0.1μF 25V
C90	2539014002	CK45=1E683M	0.068μF 25V
C42	2538010007	CK45=2GAC103P	0.01μ 400V

Ref. No.	Part No.	Part Name	Remarks
C3,4	2544128006	CE04W1A220=	Electrolytic 22μF 10V
C9,10,	2544129005	CE04W1A470=	47μF 10V
C7,13, 20	2544130007	CE04W1A101=	100μF 10V
C6,12	2544135002	CE04W1C470=	47μF 16V
C5,11	2544163032	CE04W1C102M	1000μF 16V
C8	2544197008	CE04W1C222M	2200μF 16V
C18~19	2544138009	CE04W1E470=	47μF 25V
C17	2544104031	CE04W1E221M	220μF 25V
C2	2546071009	CE04W1E103=	10000μF 25V
C10,14,28	2544140000	CE04W1V4R7=	4.7μF 35V
C16	2544165014	CE04W1V471M	470μF 35V
C43	2544147003	CE04W1H2R2=	2.2μF 50V
OTHER PARTS GROUP			
	4170140207	RADIATOR	
	3998031007	CERAMIC	
	2048110002	RESONATOR	
	2032075001	8P DIN JACK	
CN2,3	2032075001	2P CONNE. BASE	
CN1,10	2035622066	5P MINI CONN. PIN	
CN11	2035622082	6P MINI CONN. PIN	
CN4	2035622037	8P MINI CONN. PIN	
CN5	2031637037	4P EI CON	
CN8	2045408018	7P EI CON	
CN7	2045408034	7P EI CON	
CN12	2041639001	6P EI CON	
CN1	2039632023	5P EI CON	
CN6	2050170001	12P BOARD BASE	
CN9,13	2035622024	4P MINI CON PIN	
	2129188005	SLIDE SWITCH	
	2129136028	POWER SW	
LF1	2398019002	LINE FILTER COIL	
	FEP1287	FUSE HOLDER	Except EU
	4118343202	POWER SW BRACKET	
	2061031032	FUSE 0.16A	Except EU
	2061031045	FUSE 0.25A	EI only

• The carbon resistors rated at ¼W are not listed herein.

WARNING:

Parts marked with  and/or shading have special characteristics important to safety. Be sure to use the specified parts for replacement.

KU-5220/KU-5221 CONTROL UNIT

Ref. No.	Part No.	Part Name	Remarks
C451~460	2124388004	TACT SWITCH	
CN451	2045413003	8P EI CON WITH W	
CN452	2041630026	5P EI CON WITH W	
CN453	2037643108	4P EI CON ASSY	

KU-5640/KU-5641 COUNTER/METER UNIT

Ref. No.	Part No.	Part Name	Part Name
SEMICONDUCTOR GROUP			
IC401	2620601104	μPD554C-141	
IC402,403	2620523004	BA668	
TR410	2730178022	2SC1740 (R/S)	
TR411	2710101006	2SA933 (R)	
TR412,413	2750043014	2SK381 (C/D)	
TR407	2690014006	DTA124XS	
409,415			
TR460~463	2690016004	DTA144WS	
TR401~406	2690015005	DTC124XS	
408,414			
416,417			
D401~405	2760049008	IS2076	
ZD401	2760236060	HZ5C2	
RESISTOR GROUP			
RT401,402	2116000044	V08PB503	50KΩB
RB401	2462010092	RK99=2B104MP4	100KΩx4 1/8W
RB402	2462012034	RK99=2B104MP8	100KΩx8 1/8W
RB403	2462018010	RK99=2B473MP6	47KΩx6 1/8W
RB404	2462011091	RK99=2B473MP3	47KΩx3 1/8W
CAPACITOR GROUP			
C407	2533627000	CC45SL1H101J	Ceramic 100PF 50V
C405	2531061008	CK45B1H272K	0.0027μF 50V
C406	2531004007	CK45B1H102K	0.001μF 50V
C402	2539011005	CK45=1E223M	0.022μF 25V
C401	2544132005	CE04W1C100=	Electrolytic 10μF 16V
412~417			
C409	2544146004	CE04W1H010=	1μF 50V
C408	2544147003	CE04W1H2R2=	2.2μF 50V
410,411			
C403,404	2551121083	CQ93M1H333J	Film 0.033μF 50V
OTHER PARTS GROUP			
	3934013005	FL METER	FIP24A
	4428141107	METER HOLDER	
LE401	3939189015	LED (MU03-5201)	GR
CN401	2035622079	7P MINI CONNE PIN	
CN402,406	2035622082	6P MINI CONNE PIN	
CN403	2031639040	4P EI CON WITH WIRE	
CN404	2035622066	5P MINI CONNE PIN	
CN405,407	2035622008	3P MINI CONNE PIN	
CN408	2035622024	4P MINI CONNE PIN	
CN409	2032075001	2P CONNE BASE	
CN410	2031638096	2P EI CON WITH WIRE	
L401	2358014034	INDUCTOR	

• The carbon resistors rated at 1/4W are not listed herein.

KU-5620/KU-5621 HX PRO UNIT

Ref. No.	Part No.	Part Name	Remarks
SEMICONDUCTOR GROUP			
IC851	2630284003	M5219P	
IC801,802	2630189001	M5218L	
TR801,802	2730311009	2SC1741 (R)	
TR851,852	2730245023	2SC2603 (E/F)	
TR853	2710101006	2SA933 (R)	
TR854~856	2730178022	2SC1740 (R/S)	
D801~804	2760049008	IS2076	
RESISTOR GROUP			
RT801,802	2116000073	V08PB203	
851,852			
VR851	2118077004	V1220V30KB501	BIAS FINE VR 500ΩB
CAPACITOR GROUP			
C809,810	2533627000	CC45SL1H101J	Ceramic 100PF 50V
C807,808	2533635005	CC45SL1H221J	220PF 50V
C801,802	2531054057	CK45B2H101K	100PF 500V
C854	2531007004	CK45B1H332K	0.0033μF 50V
C851	2531062007	CK45B1H392K	0.0039μF 50V
C852	2544140000	CE04W1V4R7-	Electrolytic 4.7μF 16V Film
C811,812	2551072006	CQ93M1H103K	0.01μF 50V
C853	2551073005	CQ93M1H123K	0.012μF 50V
C805,806	2554077024	CQ93P2A122J	0.0012μF 100V
C855	2554078081	CQ93P2A562J	0.0056μF 100V Metallized
C803,804	2561030070	CF93B2A104J	0.1μF 100V
C813,814	2561030025	CF93B2A224J	0.22μF 100V
OTHER PARTS GROUP			
T851	2398024000	OSC COIL	
L801,802	2390007009	HX STEP UP COIL	
L851	2358005030	INDUCTOR	
CN801	2035622008	3P MINI CONNE PIN	
CN802	2035622024	4P MINI CONNE PIN	
CN803	2032075001	2P CONNE BASE	
CN804	2035691071	3P EI CON WITH WIRE	
CN805	2036143007	4P EI CON WITH WIRE	

• The carbon resistors rated at 1/4W are not listed herein.

PARTS LIST OF EXPLODED VIEW (DR-M33HX)

Ref. No.	Part No.	Part Name	Remarks
201	4118341602	CHASSIS	
	4118341615	CHASSIS	BK, E1 only
	4118341518	CHASSIS	E1 only
202	KU-5211	PWR LOGIC UNIT	
203	KU-5610	AUDIO PWB UNIT	
204	KU-5220	CONTROL UNIT	
205	KU-5640	COUNTER/METER UNIT	
206	1038244400	FRONT CHASSIS	
207	3380088008	V. MECHA 83	
208	4118347101	EARTH PLATE (A)	
209	4148198003	SHIELD BRACKET	
210	4118346115	ANGLE	
⚠	2339082001	POWER TRANS	E1 only
	2339084009	POWER TRANS	EU only
	2339083107	POWER TRANS	EA only
212	4118342410	TRANS BRACKET	
	4118342407	TRANS BRACKET	E1, EU only
⚠	2062002031	AC CORD	E2
	2006031026	AC CORD	E1
	2006019310	AC CORD	EA
	2062004005	AC CORD WITH LABEL	BK
	2062019008	AC CORD	EU
⚠	4450018004	CORD BUSH	E1, EU only
	MD-3802	CORD BUSH	E1, EU only
	MD-2982H	CORD BUSH	EA only
215	KU-52112	POWER SW PWB	
216	4118343202	POWER SW BRACKET	
218	1058089108	BOTTOM COVER	
219	4610162004	FELT PAD	
220	1438041025	METER WINDOW	
221	1030820039	FRONT ESCUTCHEON	BK
	1030820013	FRONT ESCUTCHEON	
222	1138174108	PUSH KNOB (A)	BK
	1138174111	PUSH KNOB (A)	
223	1138175220	CONTROL BUTTON	BK
	1138175217	CONTROL BUTTON	
224	4118421111	PRESS BAR	
225	1138179006	PUSH BUTTON (A)	BK
	1138179019	PUSH BUTTON (A)	
226	1138180105	BUTTON SHAFT	
227	4638623004	SPRING	
228	1138181007	PUSH BUTTON (B)	BK
	1138181010	PUSH BUTTON (B)	
229	4318098108	PUSH SW LEVER	
230	4318101024	P.S. LEVER ASS'Y	BK
	4318101011	P.S. LEVER ASS'Y	
231	4318102023	EJECT KNOB ASS'Y	BK
	4318102010	EJECT KNOB ASS'Y	
232	4318104102	EJECT PLATE	
233	1030802002	FRONT PANEL ASS'Y	BK
	1030802028	FRONT PANEL ASS'Y	
234	KU-52111	TIMER SW PWB	
235	1138155130	SLIDE KNOB (B)	BK
	1138155143	SLIDE KNOB (B)	

WARNING:

Parts marked with ⚠ and/or shading have special characteristics important to safety. Be sure to use the specified parts for replacement.

Ref. No.	Part No.	Part Name	Remarks
236	1128112109	VOL. KNOB (A)	BK
	1128112112	VOL. KNOB (A)	
237	1128113108	VOL. KNOB (B)	BK
	1128113111	VOL. KNOB (B)	
238	1128114000	VOL. KNOB (C)	BK
	1128114013	VOL. KNOB (C)	
239	1038253103	C. WINDOW ASS'Y	BK
	1038253129	C. WINDOW ASS'Y	
240	1028319251	TOP COVER	BK
	1028319248	TOP COVER	
	1028319277	TOP COVER	BK, EA only
	1028319235	TOP COVER	EA only
241	4428055002	P.W.B. SUPPORT	
242	4428141107	METER HOLDER	
243	4118420206	SHIELD SHEET	
244	4128747102	SHIELD BRACKET	
246	1038249104	SIDE FRAME (L)	BK
	1038249117	SIDE FRAME (L)	
247	1038250106	SIDE FRAME (R)	BK
	1038250119	SIDE FRAME (R)	
248	4170140207	RADIATOR	BK
	4170140100	RADIATOR	
249	2048110002	8P DIN JACK	
250	2129223009	PUSH SWITCH	
251	2129224008	PUSH SWITCH	
252	2048114008	4P PIN JACK	
253	2118075006	V1611V..503KA	50KΩ
254	2118076005	V2620V..103KA	10KΩ
255	2048109013	HEADPHONE JACK	
256	3934013005	FL METER	
257	2124388004	TACK SWITCH	
259	2129136028	POWER SW	
261	KU-56401	LED PWB ASS'Y	
262	KU-5620	HX PRO PWB UNIT	
272	4458028009	CORD HOLDER	
273	4428166108	BIAS VOL. PLATE	
274	KU-56201	BIAS ADJ PWB	
⚠	4737500015	3x8 CBTS (P)	
301	4737500015	3x8 CBTS (P)	
302	4737501001	3x10 CBTS (P)	
303	4713303016	3x6 CBS	
304	4737002005	3x6 CBTS (S)	
305	4737004003	4x8 CBTS (S)	
306	4737505007	2.6x8 CBTS (P)	
307	4737003004	3x8 CFTS (S)	
308	4737500044	3x8 CBTS (P) BK	
309	4737503025	4x8 CTTs (P)	BK
	4737503009	4x8 CTTs (P)	
310	4713305014	3x10 CBS	
311	4751160042	WASHER	
312	4730359014	3x16 CRTS (2)	E1 only
314	4737002018	3x8 CBTS (S)	
315	4713201011	2.6x4 CBS	

Remarks symbols in the parts list refer to the following countries and areas.

EA: Australia
 EK: United Kingdom
 EU: U.S.A.

E1: Multiple voltage model
 E2: European continent

* Remarks symbols (BK) in the parts list means that the color of the front panel is Black.

EXPLODED VIEW OF CABINET AND CHASSIS GROUP (DR-M33HX)

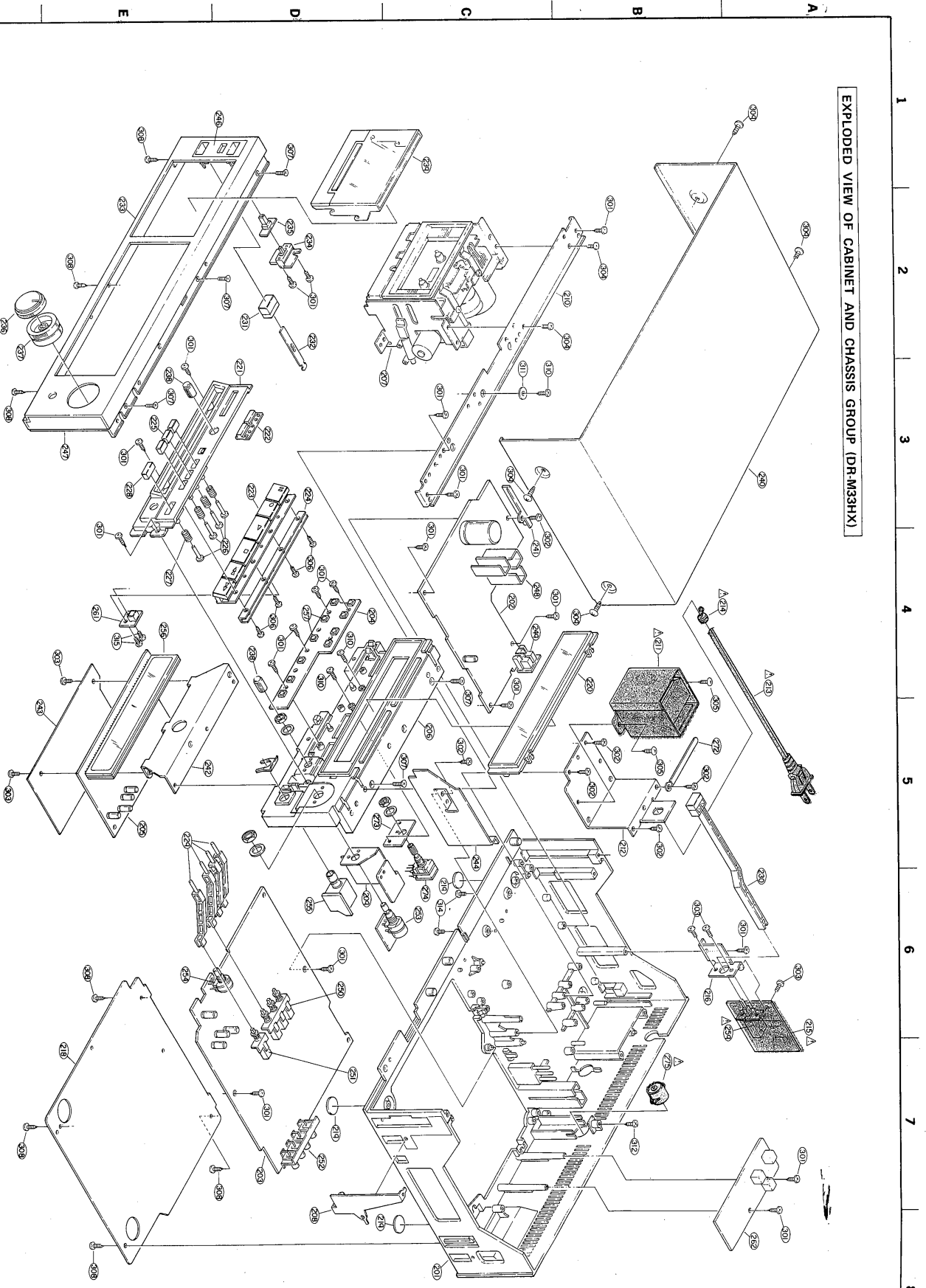

EXPLODED VIEW OF MECHANISM 83 UNIT (DR-M33HX)

1 2 3 4 5 6 7 8

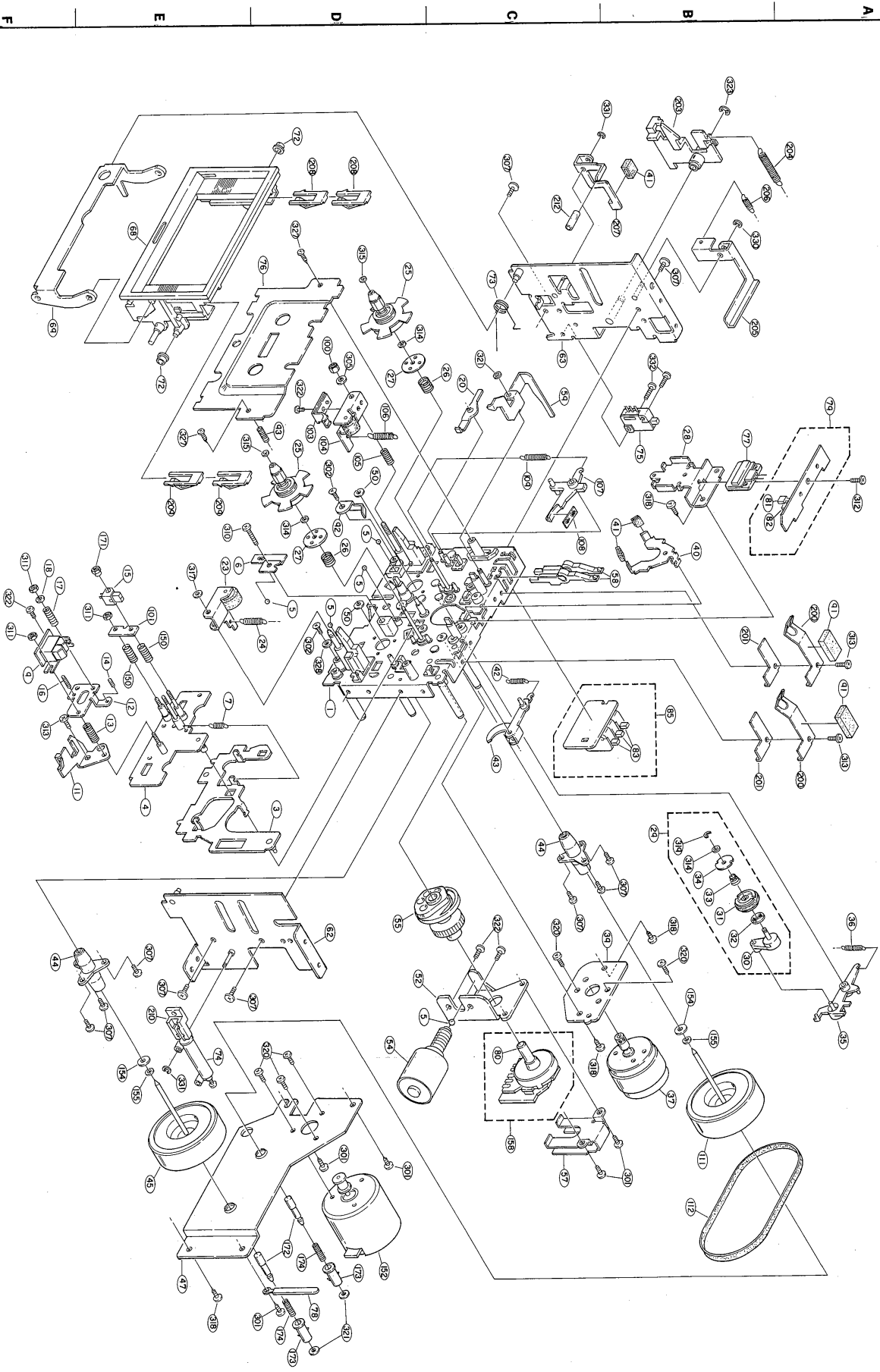

WIRING DIAGRAM (DRM33HX)

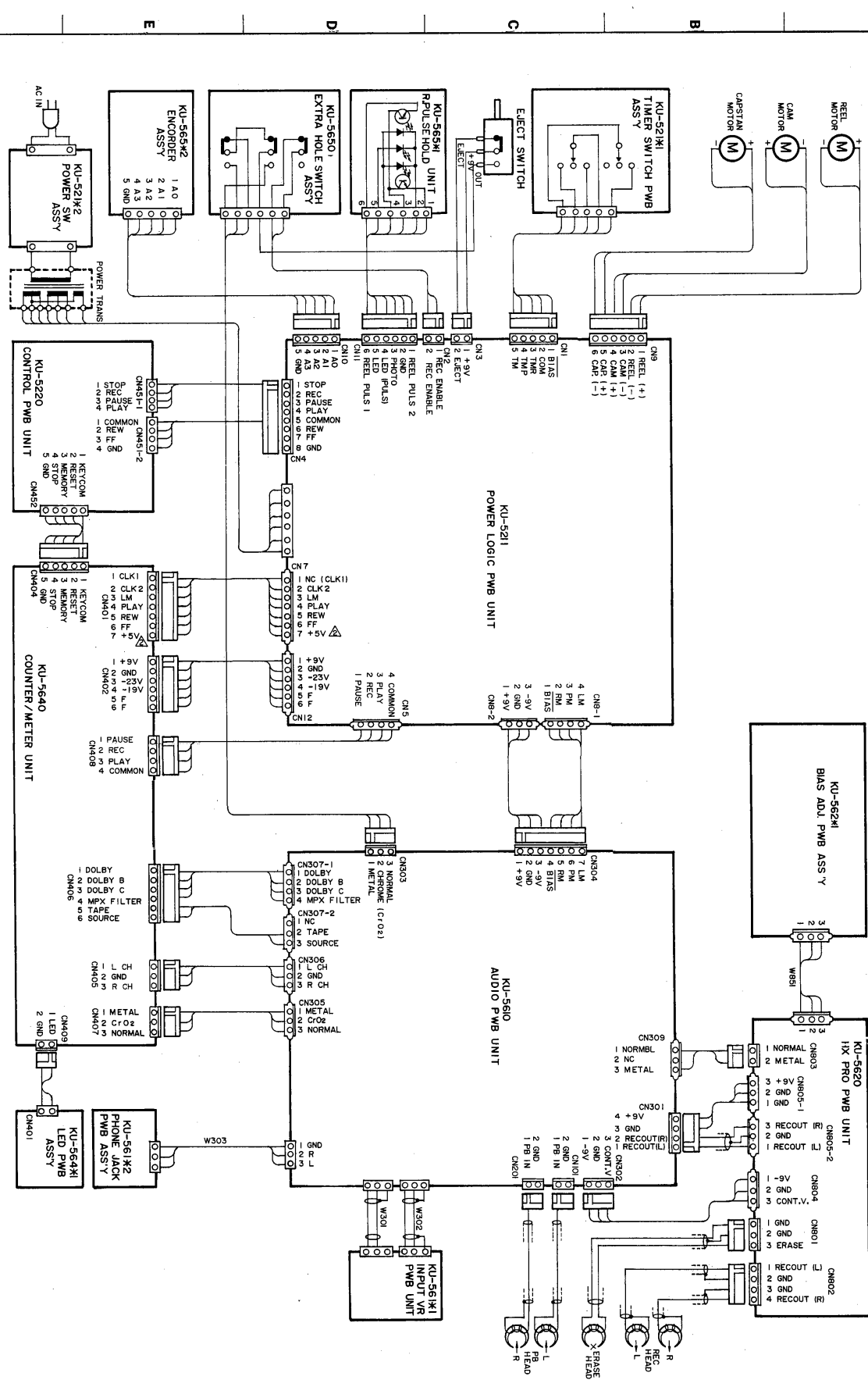

SCHEMATIC DIAGRAM OF HX PRO UNIT (DR-M3HX)

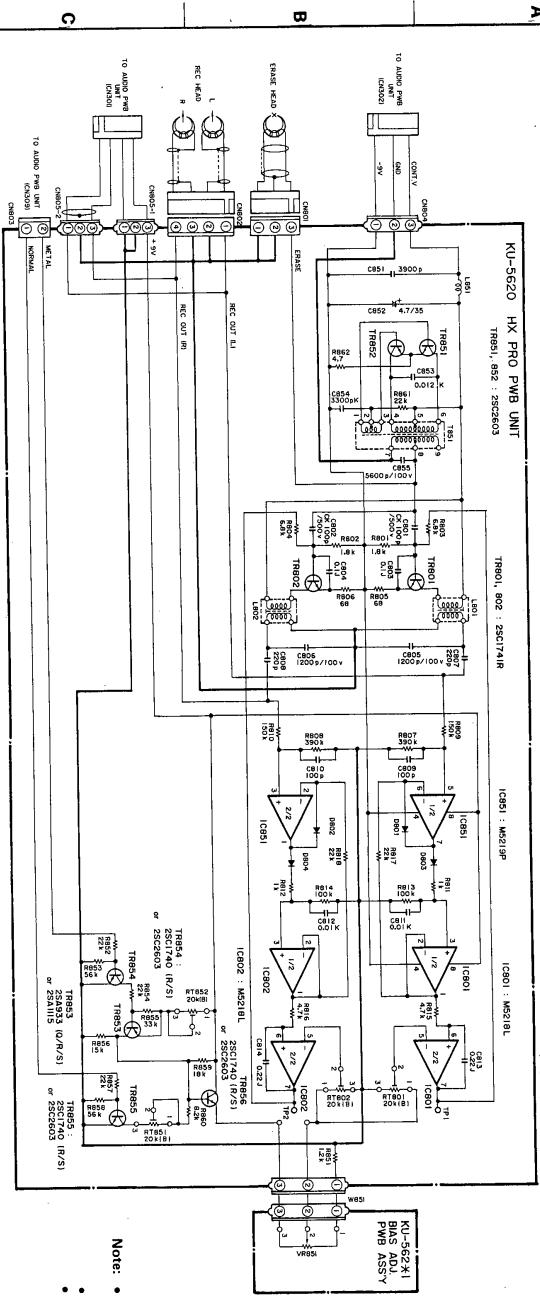

P. W. BOARD OF KU-5620 HX PRO UNIT (DR-M3HX)

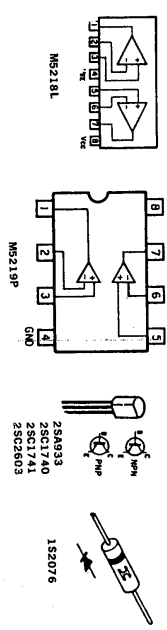
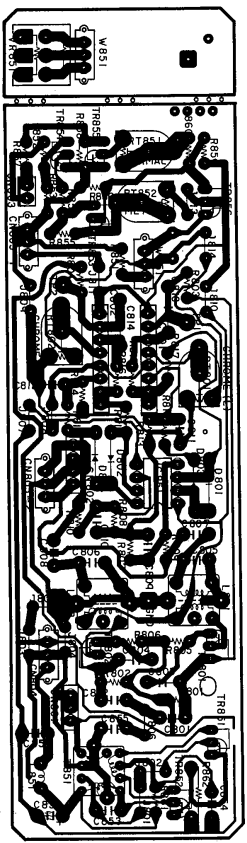

Note:

- Resistance shall be 1/4W unless otherwise specified and the unit is Ω.
- The unit of capacitor is μF, P is pF unless otherwise specified.
- This circuit diagram shows the basic circuit. It is subject to change for the purpose of improvement.

SCHEMATIC DIAGRAM OF AUDIO AMP UNIT (DR-M3HX)

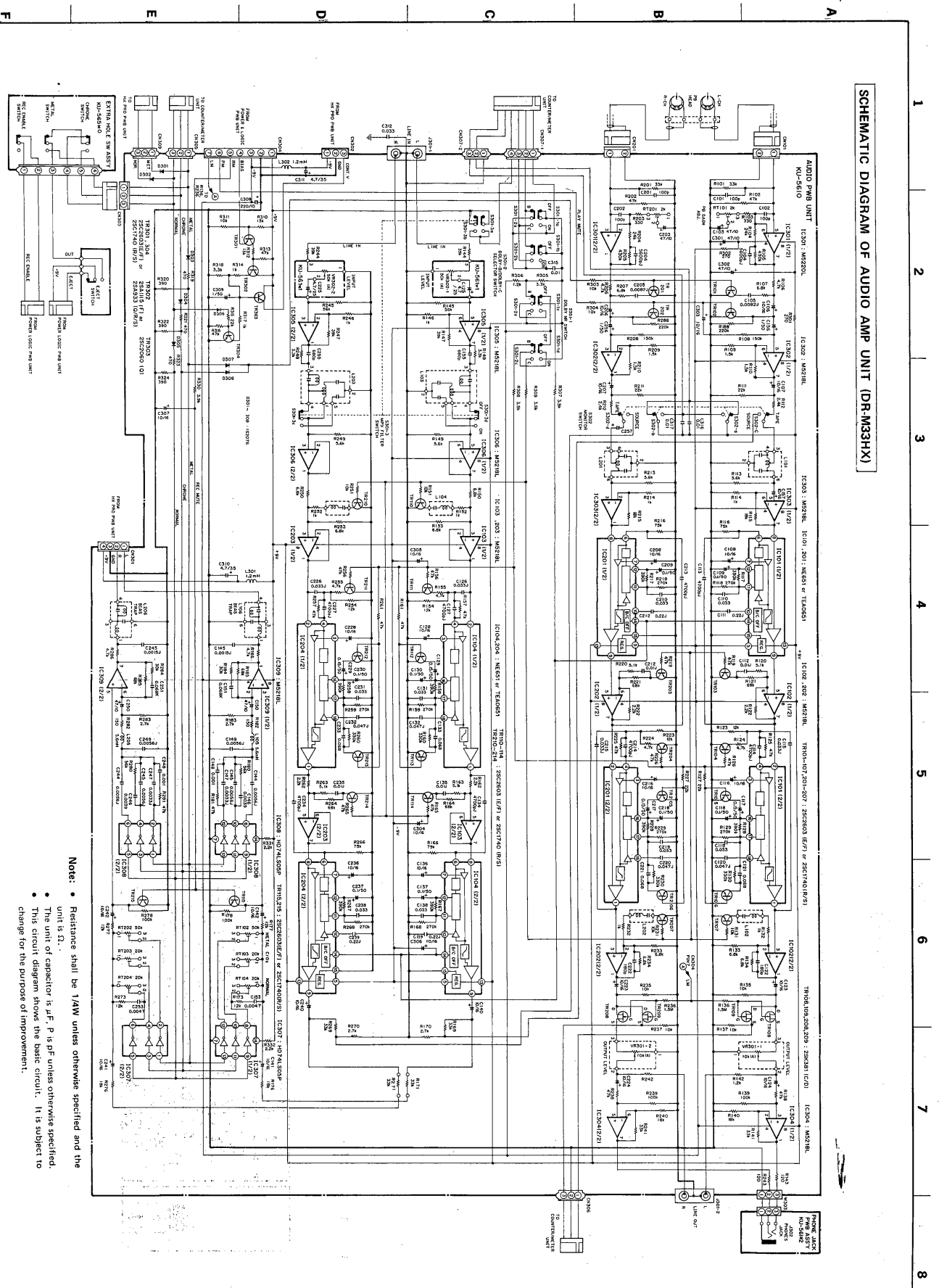

Note:

- Resistance shall be 1/4W unless otherwise specified and the unit is Ω.
- The unit of capacitor is μF. P is pF unless otherwise specified.
- This circuit diagram shows the basic circuit. It is subject to change for the purpose of improvement.

P. W. BOARD OF KU-5610 AUDIO AMP UNIT

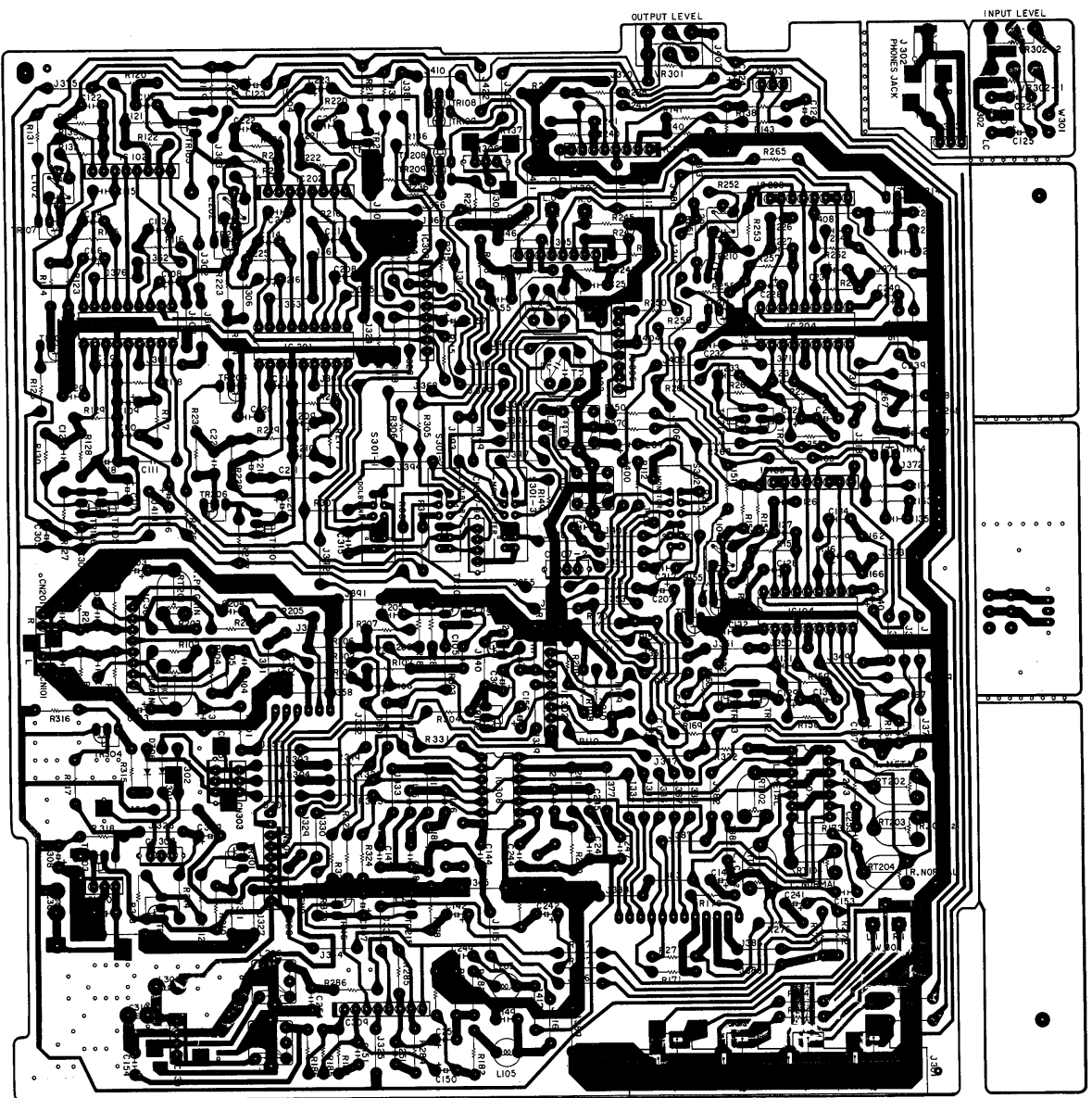

1 2 3 4 5 6 7 8

F E D C B A

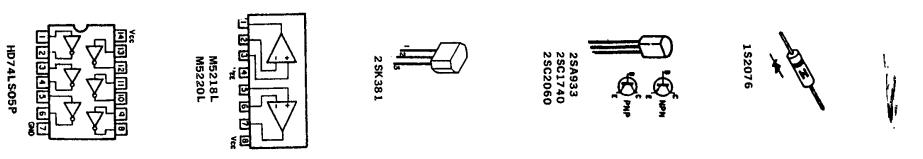

SCHEMATIC DIAGRAM OF POWER AND LOGIC UNIT (DR-M3HX)

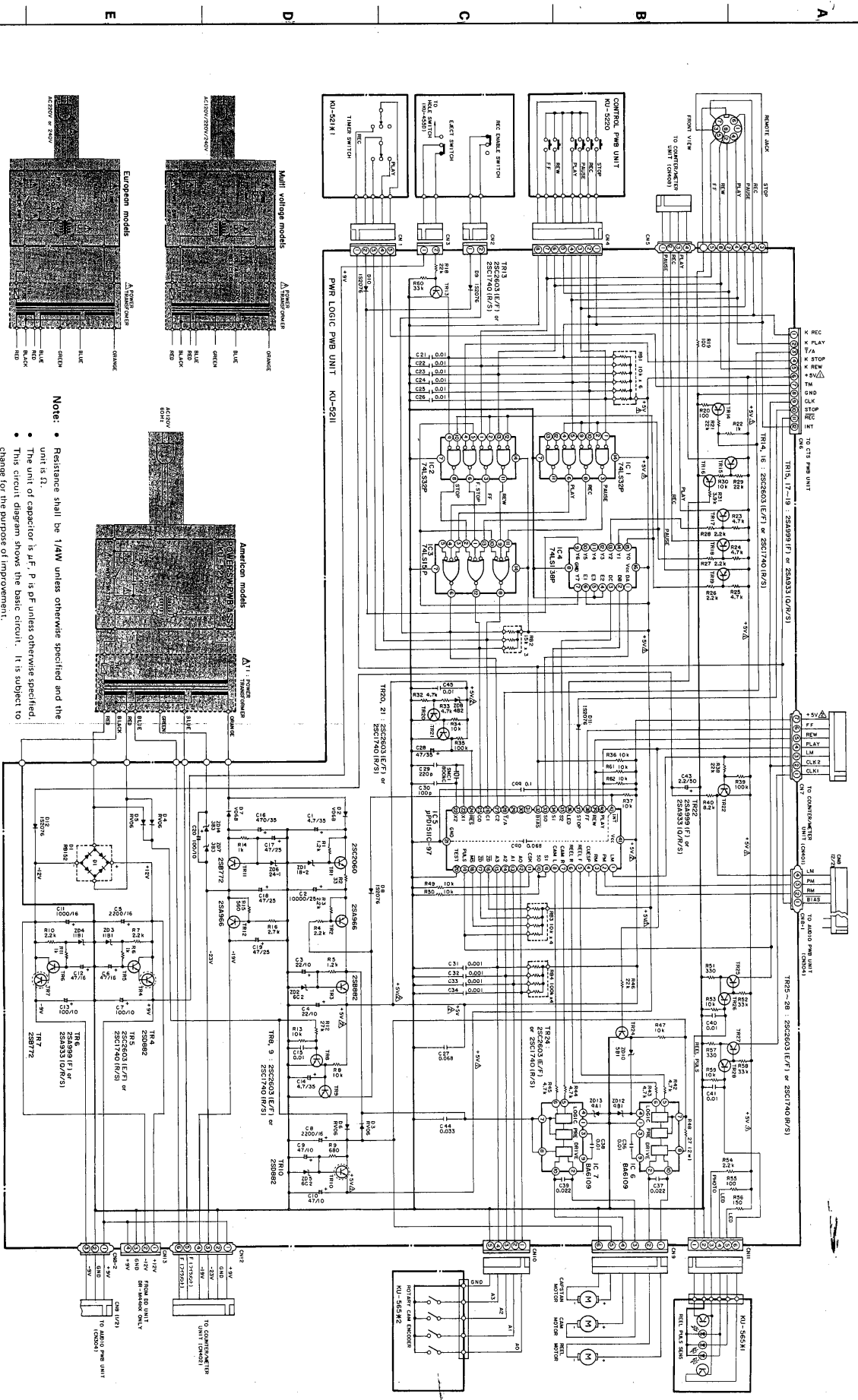

- Note:**
- Resistance shall be 1/4W unless otherwise specified and the unit is Ω.
 - The unit of capacitor is μF, P is pF unless otherwise specified.
 - This circuit diagram shows the basic circuit. It is subject to change for the purpose of improvement.
 - Parts marked with Δ are of importance in respect to the safety, use the specified type without fail.

1 2 3 4 5 6 7 8

P. W. BOARD OF KU-5211 POWER AND LOGIC UNIT

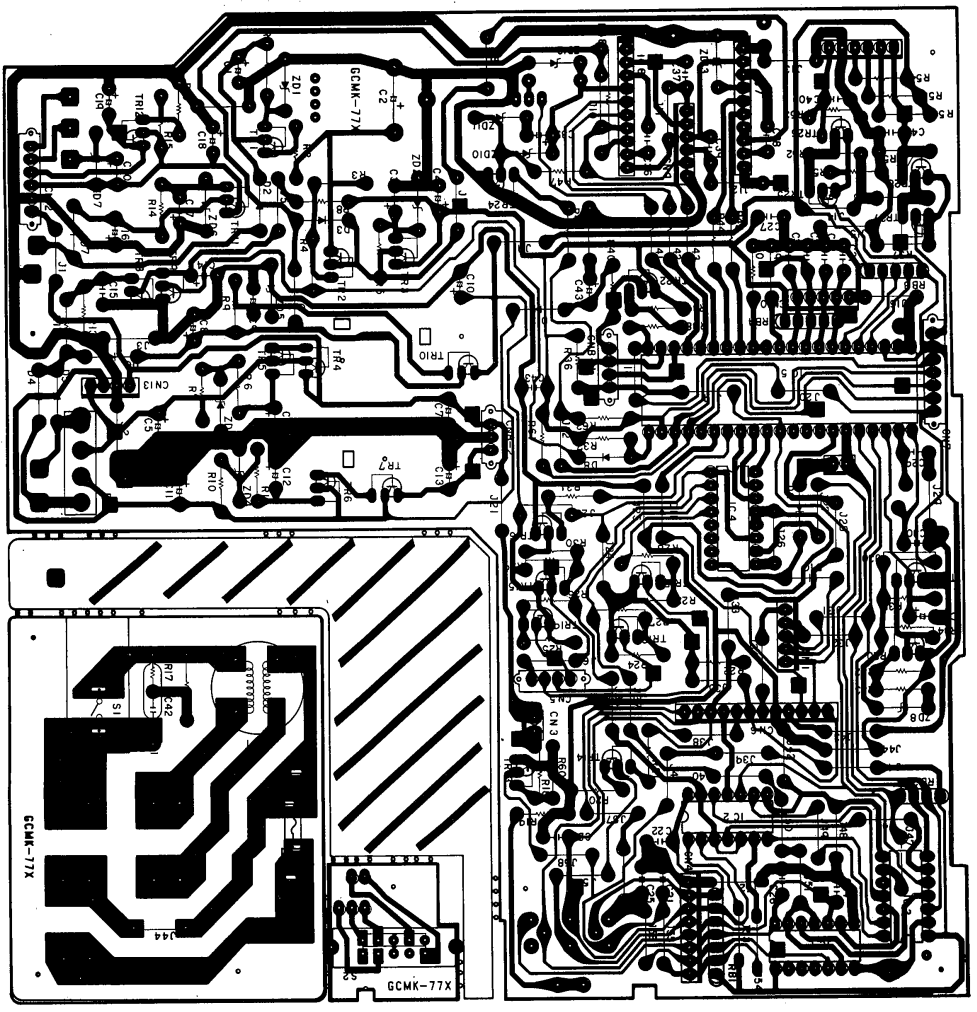

P. W. BOARD KU-5220 CONTROL UNIT

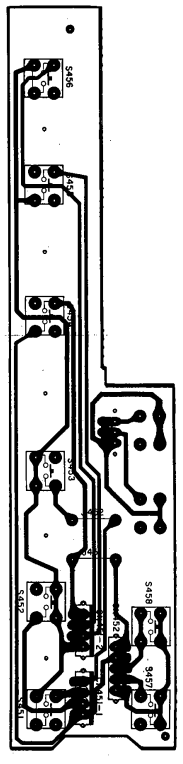

P. W. BOARD KU-5650 MECHANISM UNIT

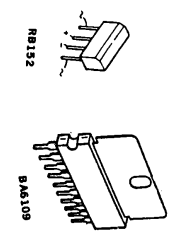
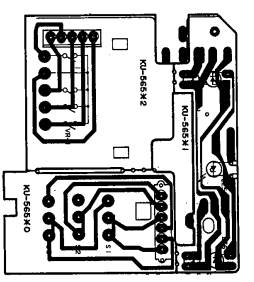

- RV06
- RV08
- Y068
- 25A933
- 25A932
- 25C2050
- 25C1740
- 152076
- H21B3
- H24B2
- H24C-3
- H25B-3
- H25A-1
- H211B-1
- H21B-2
- H224-1
- 25B742
- 25B432
- 1.8

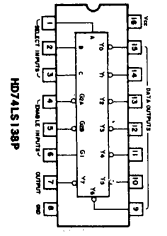
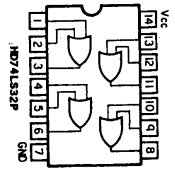

SCHEMATIC DIAGRAM OF FL COUNTER UNIT (DR-M33HX)

1 2 3 4 5 6 7 8

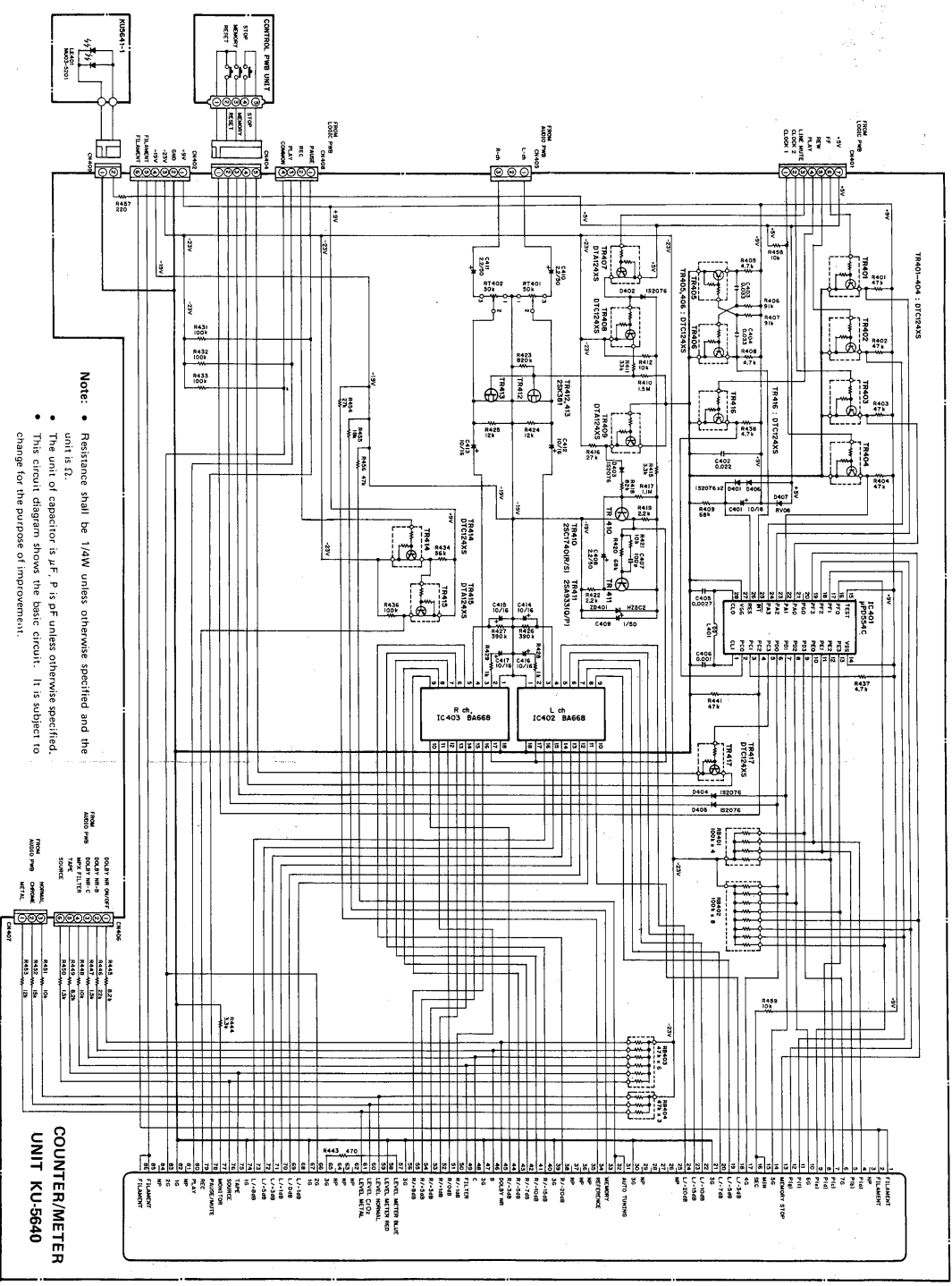

Note: • Resistance shall be 1/4W unless otherwise specified and the unit is Ω .
 • The unit of capacitor is μF , P is of unless otherwise specified.
 • This circuit diagram shows the basic circuit. It is subject to change for the purpose of improvement.

COUNTER/METER UNIT KU-5640

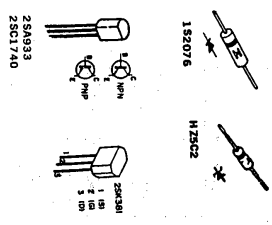
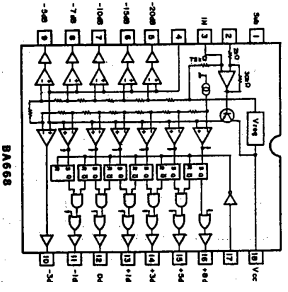

P.W. BOARD OF KU-5640 FL COUNTER UNIT

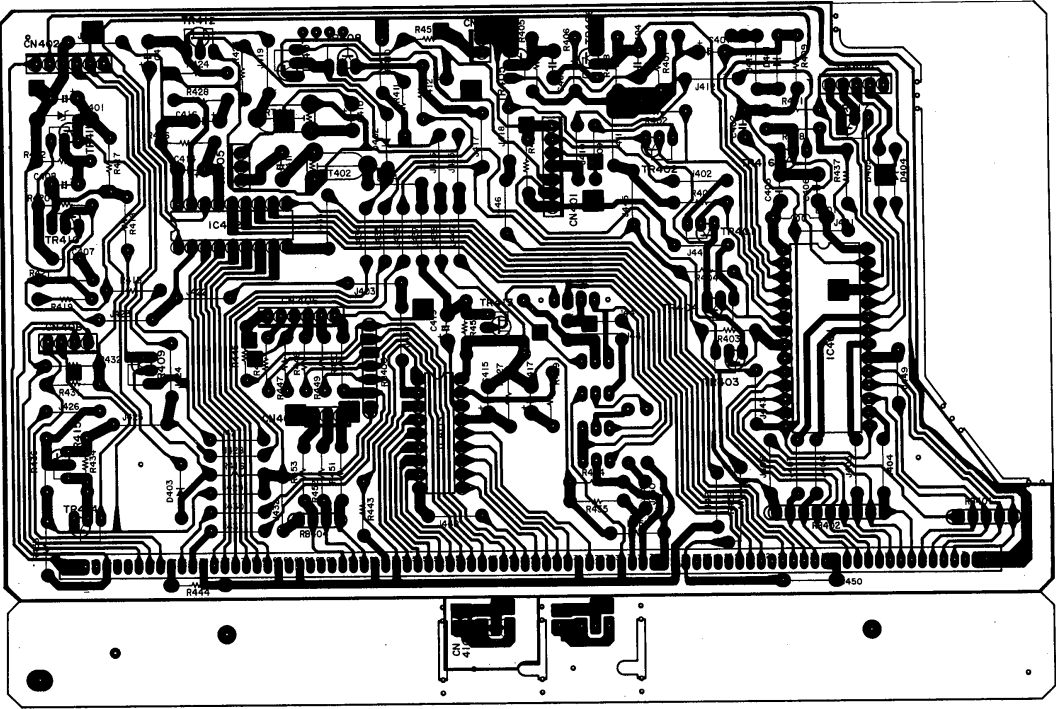

FL COUNTER METER TERMINAL FUNCTION TABLE

Termi- nal Number	Name	Function	Termi- nal Number	Name	Function
1	F	Filament	46	P(S9)	[0] display plate
2	NP	Filament	47	3G	Static display grid
3	NP	—	48	P(S10)	[1] display plate
4	P(a)	Plate (a)	49	P(S11)	[2] display plate
5	P(b)	Plate (b)	50	P(R7)	Rich [-1] dB display plate
6	7G	Counter-4 digit grid	51	P(R8)	Rich [0] dB display plate
7	P(c)	Plate (c)	52	P(R9)	Rich [+1] dB display plate
8	P(d)	Plate (d)	53	P(R10)	Rich [+3] dB display plate
9	P(e)	Plate (e)	54	P(R11)	Rich [+5] dB display plate
10	6G	Counter-3 digit grid	55	P(R12)	Rich [+8] dB display plate
11	P(f)	Plate (f)	56	3G	Static display grid
12	P(g)	Plate (g)	57	P(X1)	Blue illumination level meter display
13	P(Y1)	[MEMORY STOP] display plate	58	P(X2)	Red illumination level meter display
14	5G	Counter-2 digit grid	59	P(S12)	NORMAL tape transcription limit display plate
15	P(Y2)	[min] display plate	60	P(S13)	CO ₂ tape transcription limit display plate
16	P(Y3)	[seg] display plate	61	P(S14)	METAL tape transcription limit display plate
17	4G	Counter-1 digit counter	62	NP	—
18	P(L6)	Lch [-3] dB display plate	63	NP	—
19	P(L5)	Lch [-5] dB display plate	64	NP	Static display grid
20	P(L4)	Lch [-7] dB display plate	65	6G	REC., PLAY, and PAUSE/MUTE display grid
21	3G	Static display grid	66	2G	Static display grid
22	P(L3)	Lch [-10] dB display plate	67	1G	Lch [-1] dB display plate
23	P(L2)	Lch [-15] dB display plate	68	P(L7)	Lch [0] dB display plate
24	P(L1)	Lch [-20] dB display plate	69	P(L8)	Lch [+1] dB display plate
25	NP	—	70	P(L9)	Lch [+3] dB display plate
26	P(S1)	—	71	P(L10)	Lch [+5] dB display plate
27	P(S2)	—	72	P(L11)	Lch [+8] dB display plate
28	P(S3)	—	73	P(L12)	Lch [+8] dB display plate
29	NP	—	74	1G	Static display grid
30	3G	Static display grid	75	P(S15)	TAPE display plate
31	P(S4)	[AUTO TUNING] display plate	76	P(S16)	[SOURCE] display plate
32	P(S5)	— display plate	77	P(S17)	[MONITOR] display plate
33	P(S6)	[MEMORY] display plate	78	P(Z3)	[PAUSE/MUTE] display plate
34	P(S7)	[REFERENCE] display plate	79	P(Z2)	[REC] display plate
35	NP	—	80	P(Z1)	[PLAY] display plate
36	NP	—	81	NP	—
37	NP	—	82	1G	Static display grid
38	P(R1)	Rich [-20] dB display plate	83	2G	REC., PLAY, and PAUSE/MUTE display grid
39	3G	Static display grid	84	NP	—
40	P(R2)	Rich [-15] dB display plate	85	F	Filament
41	P(R3)	Rich [-10] dB display plate	86	F	Filament
42	P(R4)	Rich [-7] dB display plate			
43	P(R5)	Rich [-5] dB display plate			
44	P(R6)	Rich [-3] dB display plate			
45	P(S8)	[DOLBY NR] display plate			

EXPLODED VIEW OF CABINET AND CHASSIS GROUP (DR-M44HX)

1 2 3 4 5 6 7 8

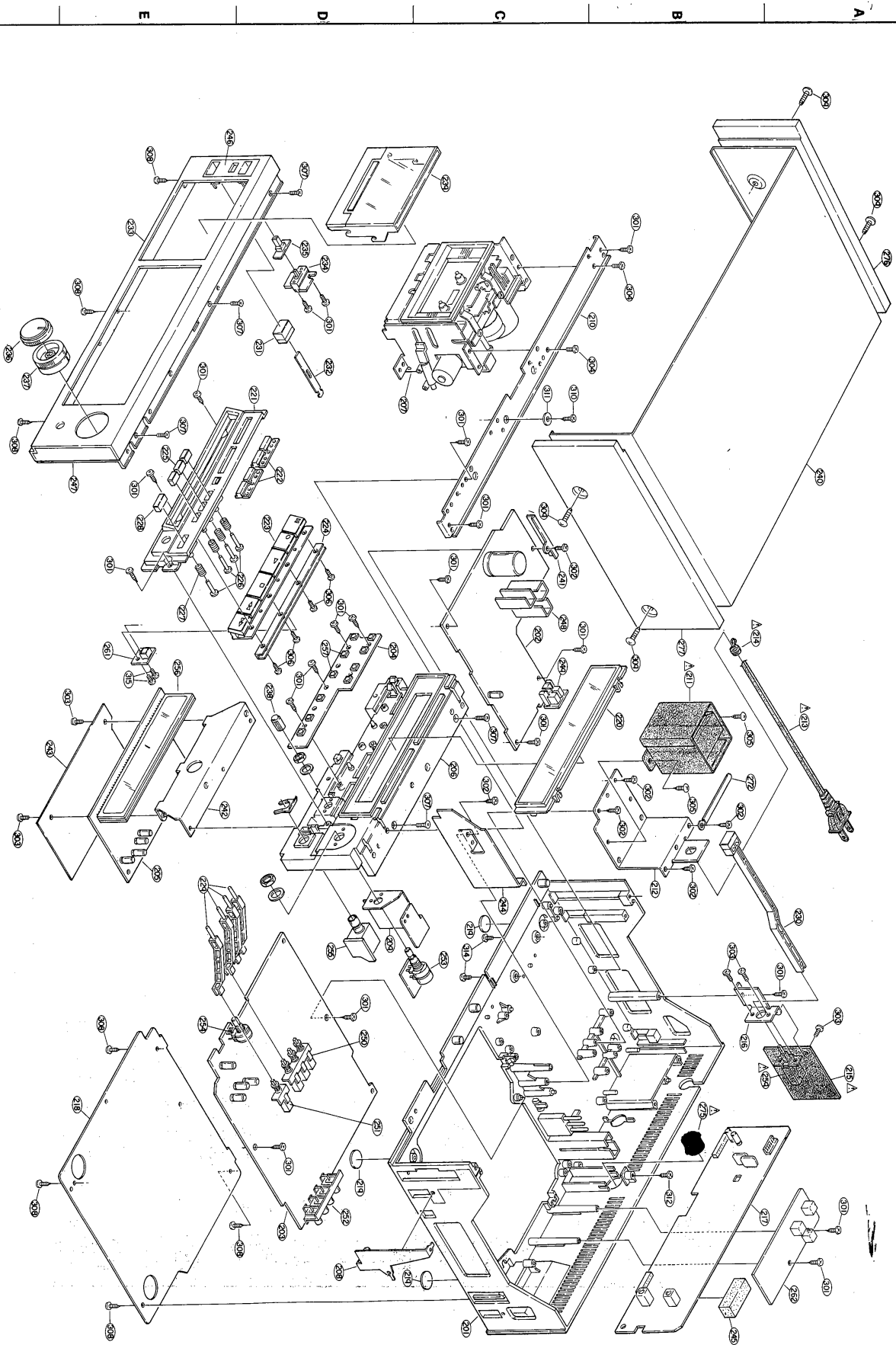

EXPLODED VIEW OF MECHANISM 53 UNIT (DR-M44HX)

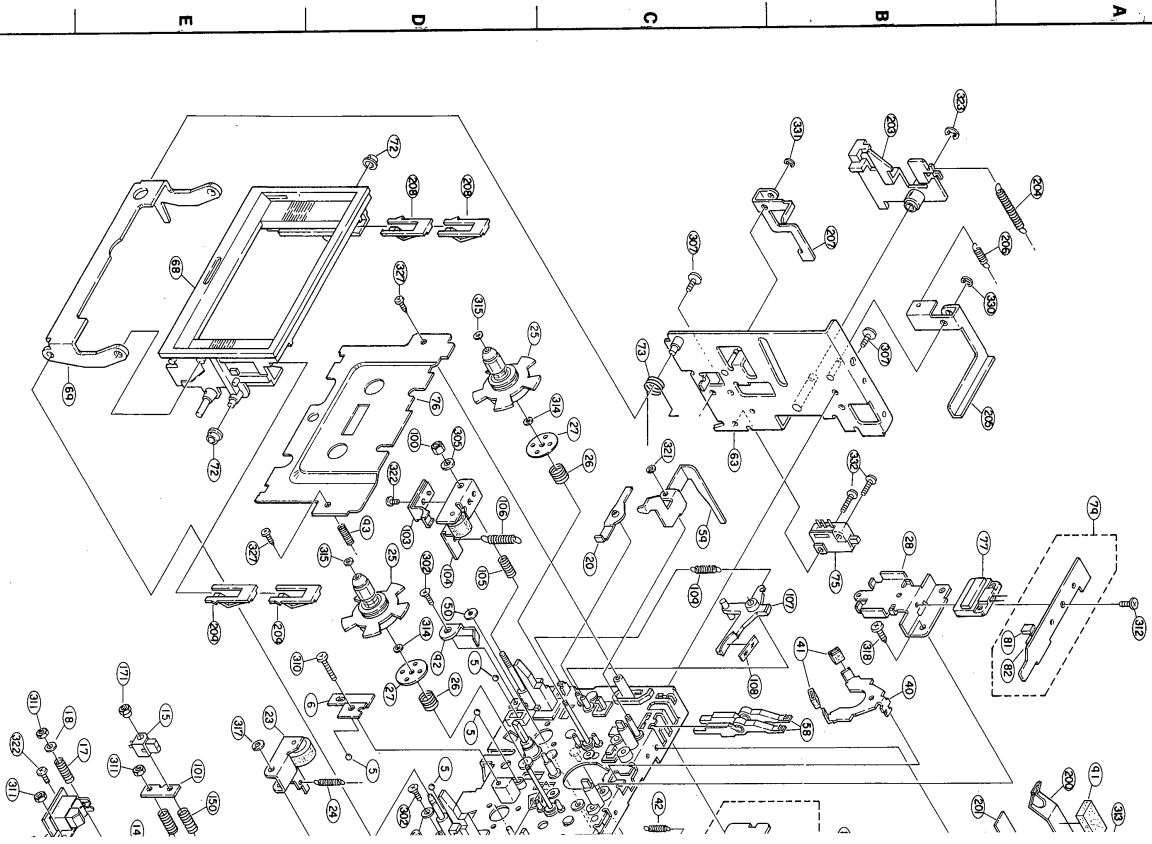

PARTS LIST OF EXPLODED VIEW (DR-M44 HX)

Ref. No.	Part No.	Part Name	Remarks
201	4118341602	CHASSIS	BK, E1 only
202	KU-5212	PWR LOGIC UNIT	
203	KU-5611	AUDIO PWB UNIT	
204	KU-5221	CONTROL UNIT	
205	KU-5641	COUNTER/METER UNIT	
206	1038244400	FRONT CHASSIS	
207	3380909009	V. MECHA 53	
208	4118347101	EARTH PLATE (A)	
209	418198003	SHIELD BRACKET	
210	4118346115	ANGLE	
211	3239322001	POWER TRANS	E1, only
212	2391929009	POWER TRANS	E1, only
213	2390831007	POWER TRANS	E1, only
214	4118342410	TRANS BRACKET	E1, EU only
215	4118342407	TRANS BRACKET	E1, EU only
216	2092002001	AC CORP.	
217	7066431006	AC CORP.	
218	2018015310	AC CORP.	
219	2016201008	AC CORP. WITH LABEL	
220	416018004	CORP. BUSH	
221	103824002	CORP. BUSH	
222	1138174108	PUSH KNOB (A)	
223	1138174111	PUSH KNOB (A)	
224	1138175220	CONTROL BUTTON	
225	1138179019	PUSH BUTTON (A)	
226	1138180105	BUTTON SHAFT	
227	4838623004	SPRING	
228	1138181007	PUSH BUTTON (B)	
229	1138181010	PUSH BUTTON (B)	
230	4318098108	P.S. LEVER ASSY	
231	4318101024	P.S. LEVER ASSY	
232	4318101011	P.S. LEVER ASSY	
233	4318102023	ELECT KNOB ASSY	
234	4318102010	ELECT KNOB ASSY	
235	1030802015	ELECT KNOB ASSY	
236	1030802031	FRONT PANEL ASSY	
237	KU-52121	FRONT PANEL ASSY	
238	1138185130	SLIDE KNOB (B)	
239	1138185143	SLIDE KNOB (B)	

WARNING: and/or shading have special characteristics important to safety. Be sure to use the specified parts for replacement.

Ref. No.	Part No.	Part Name	Remarks
236	1128112109	VOL. KNOB (A)	BK
237	1128112112	VOL. KNOB (A)	BK
238	1128113108	VOL. KNOB (B)	BK
239	1128113111	VOL. KNOB (B)	BK
240	1128114000	VOL. KNOB (C)	BK
241	1128114013	VOL. KNOB (C)	BK
242	1038253116	C. WINDOW ASSY	BK
243	1038253132	C. WINDOW ASSY	BK
244	1028319251	TOP COVER	BK, EA only
245	1028319248	TOP COVER	BK, EA only
246	1028319277	TOP COVER	BK, EA only
247	4428055002	P.W.B. SUPPORT	
248	4428141107	METER HOLDER	
249	4118342006	SHIELD SHEET	
250	4128247102	SHIELD BRACKET	
251	4618135004	CUSHION (C)	
252	1038249104	SIDE FRAME (L)	
253	1038249117	SIDE FRAME (L)	
254	1038250106	SIDE FRAME (R)	
255	1038250119	SIDE FRAME (R)	
256	4170140207	RADIATOR	
257	2048110002	RF DIN JACK	
258	2129223009	PUSH SWITCH	
259	2129224008	PUSH SWITCH	
260	2048114008	4P PIN JACK	
261	2118075006	V620V, .103KA	
262	2118076005	V620V, .103KA	
263	2048109013	HEADPHONE JACK	
264	3934013005	FL. METER	
265	2124388004	TACT SWITCH	
266	2129196028	POWER SW	
267	KU-56411	LED PWB ASSY	
268	KU-5621	HX PRO PWB UNIT	
269	4468028008	CORD HOLDER	
270	2123318002	VOLUME SELECTOR	
271	1018418007	WOOD BOARD (L)	E1, EA, EU
272	1018419006	WOOD BOARD (R)	E1, EA, EU
273	4737500015	3x10 CRTS (P)	
274	4737500015	3x10 CRTS (P)	
275	4737500015	3x6 CRTS (S)	
276	4737500015	3x6 CRTS (S)	
277	4737505007	2.6x8 CRTS (P)	
278	4737039004	3x8 CRTS (P)	
279	4737500044	3x8 CRTS (P) BK	
280	4737509025	4x8 CRTS (P) BK	
281	4737504008	4x20 CRTS (P)	
282	4737503009	4x8 CRTS (P)	
283	4737395014	3x10 CBS	
284	4751106042	WASHER	
285	4730398014	3x16 CRTS (Z)	
286	4737002018	3x8 CRTS (S)	
287	4713201011	2.6x4 CBS	

Remarks symbols in the parts list refer to the following countries and areas:
 EA: Australia
 EK: United Kingdom
 EU: U.S.A.
 * Remarks symbols (BK) in the parts list means that the color of the front panel is Black.

WIRING DIAGRAM (DR-M44HX)

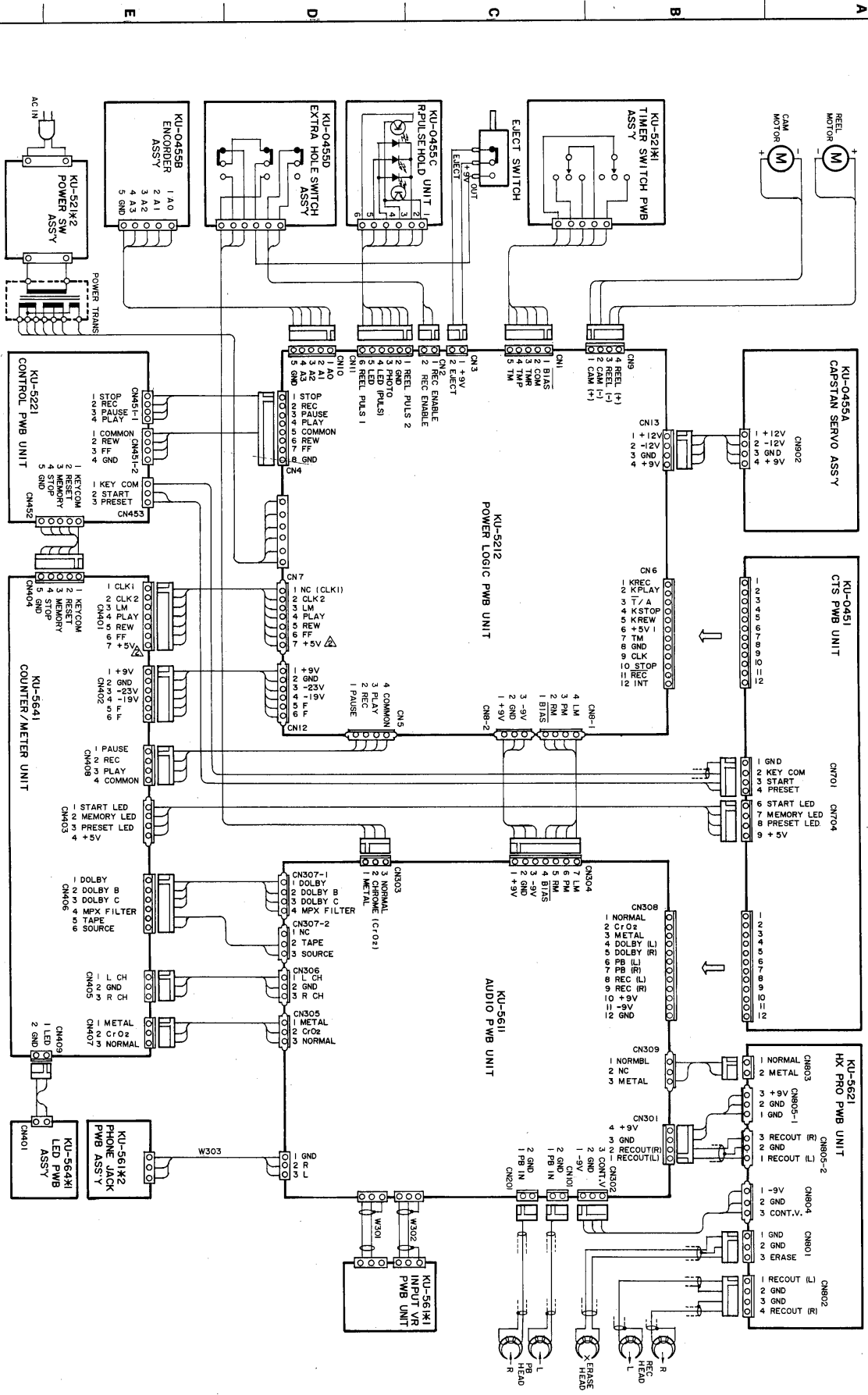

SCHEMATIC DIAGRAM OF HX PRO UNIT (DR-M4HX)

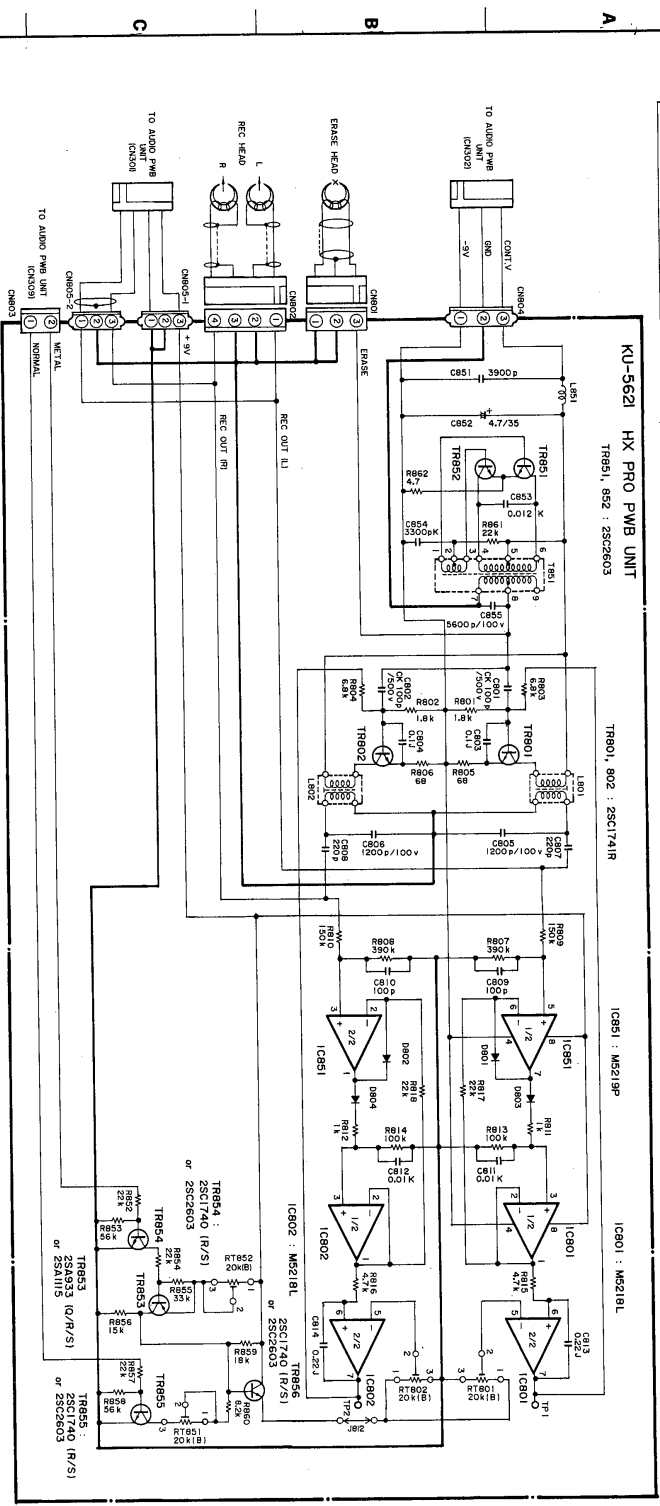

P. W. BOARD OF KU-5621 HX PRO UNIT

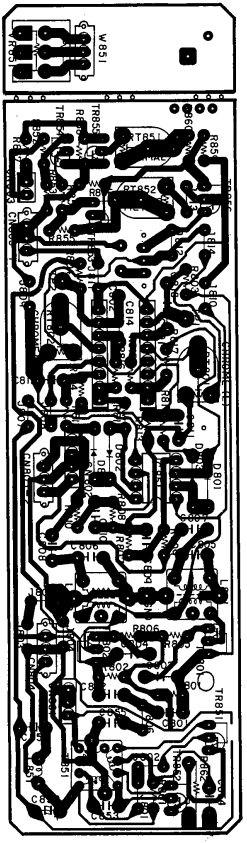

Note:

- Resistance shall be 1/W unless otherwise specified and the unit is Ω.
- The unit of capacitor is μF, P is pF unless otherwise specified.
- This circuit diagram shows the basic circuit. It is subject to change for the purpose of improvement.

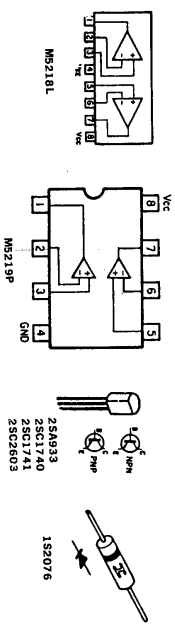

SCHEMATIC DIAGRAM OF AUDIO AMP UNIT (DR-M44HX)

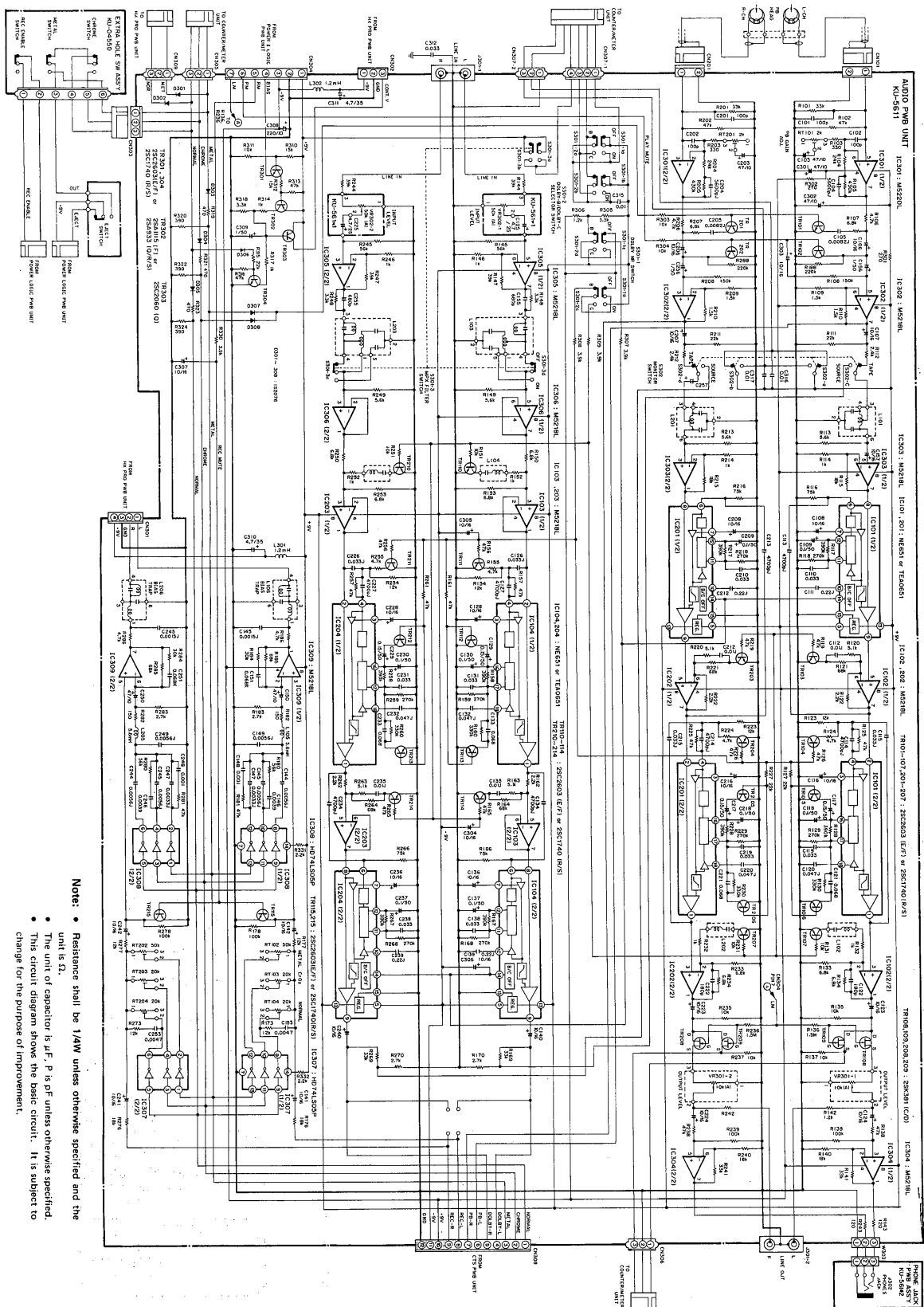

Notes:

- Resistance shall be 1/4W unless otherwise specified and the unit is Ω.
- The unit of capacitor is μF, P is pF unless otherwise specified.
- This circuit diagram shows the basic circuit. It is subject to change for the purpose of improvement.

1 2 3 4 5 6 7 8

P. W. BOARD OF KU-5611 AUDIO AMP UNIT

1 2 3 4 5 6 7 8

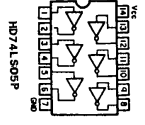
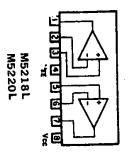
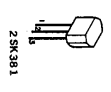
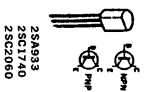
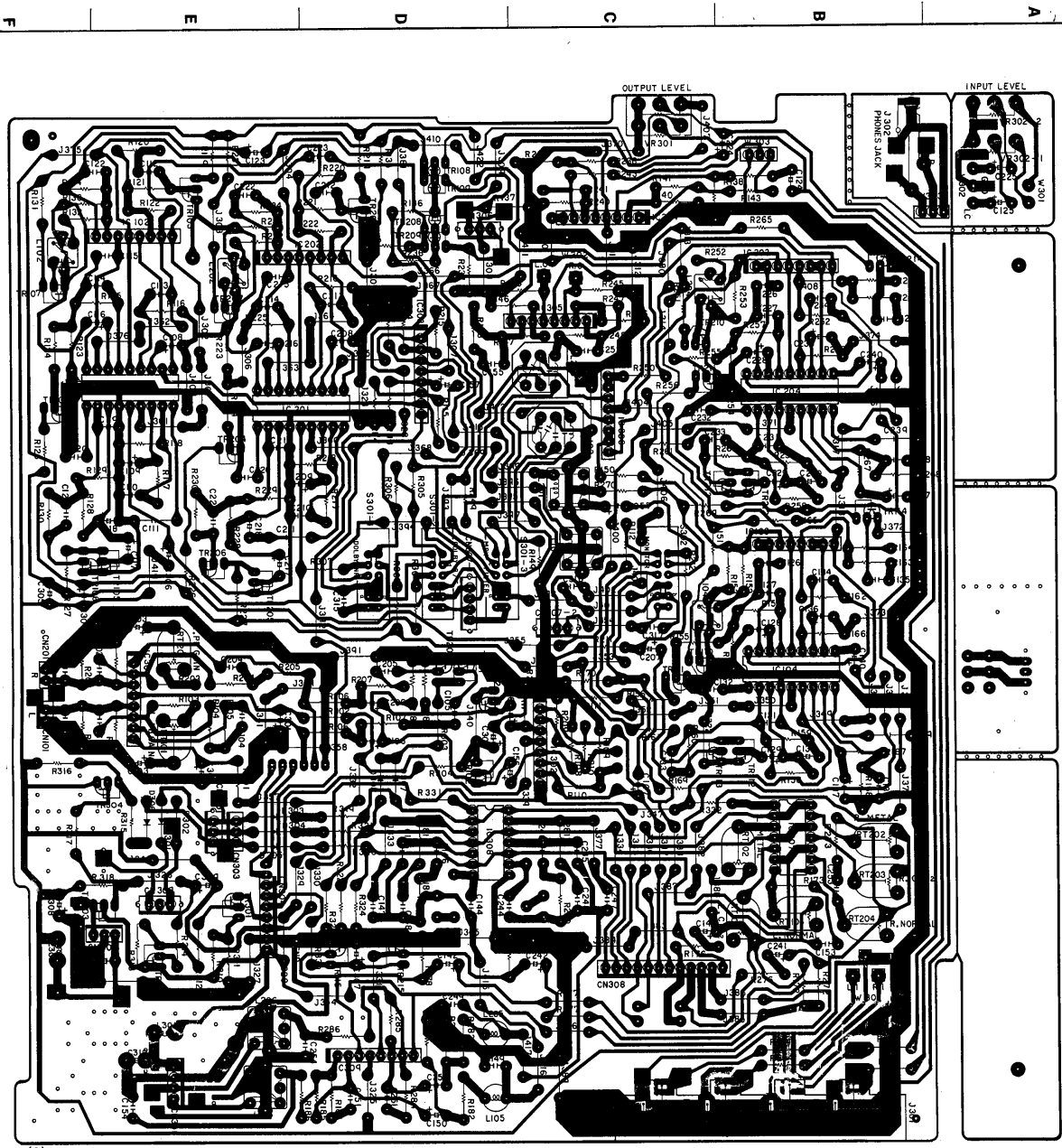

SCHEMATIC DIAGRAM OF POWER AND LOGIC UNIT (DR-M44HX)

1 2 3 4 5 6 7 8

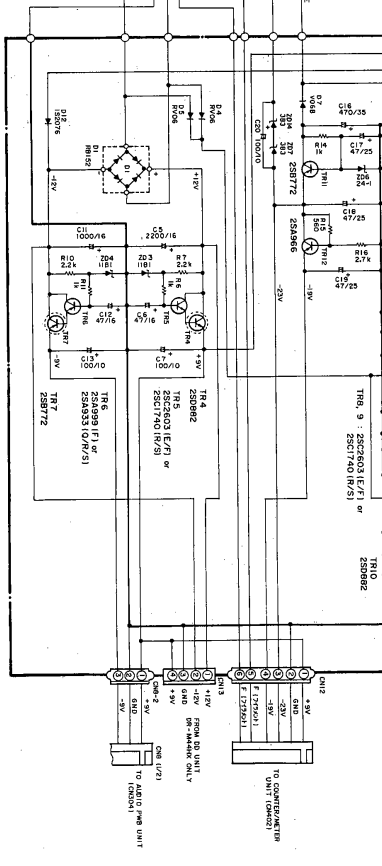
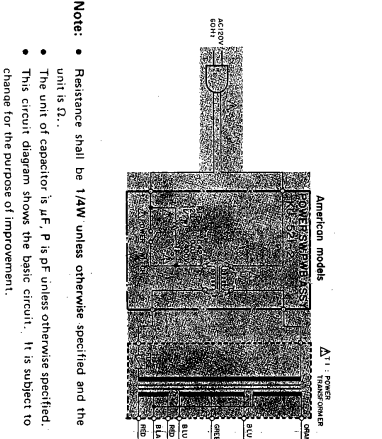
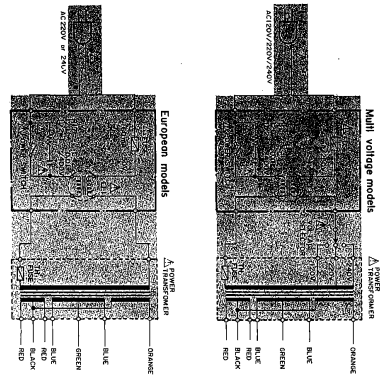
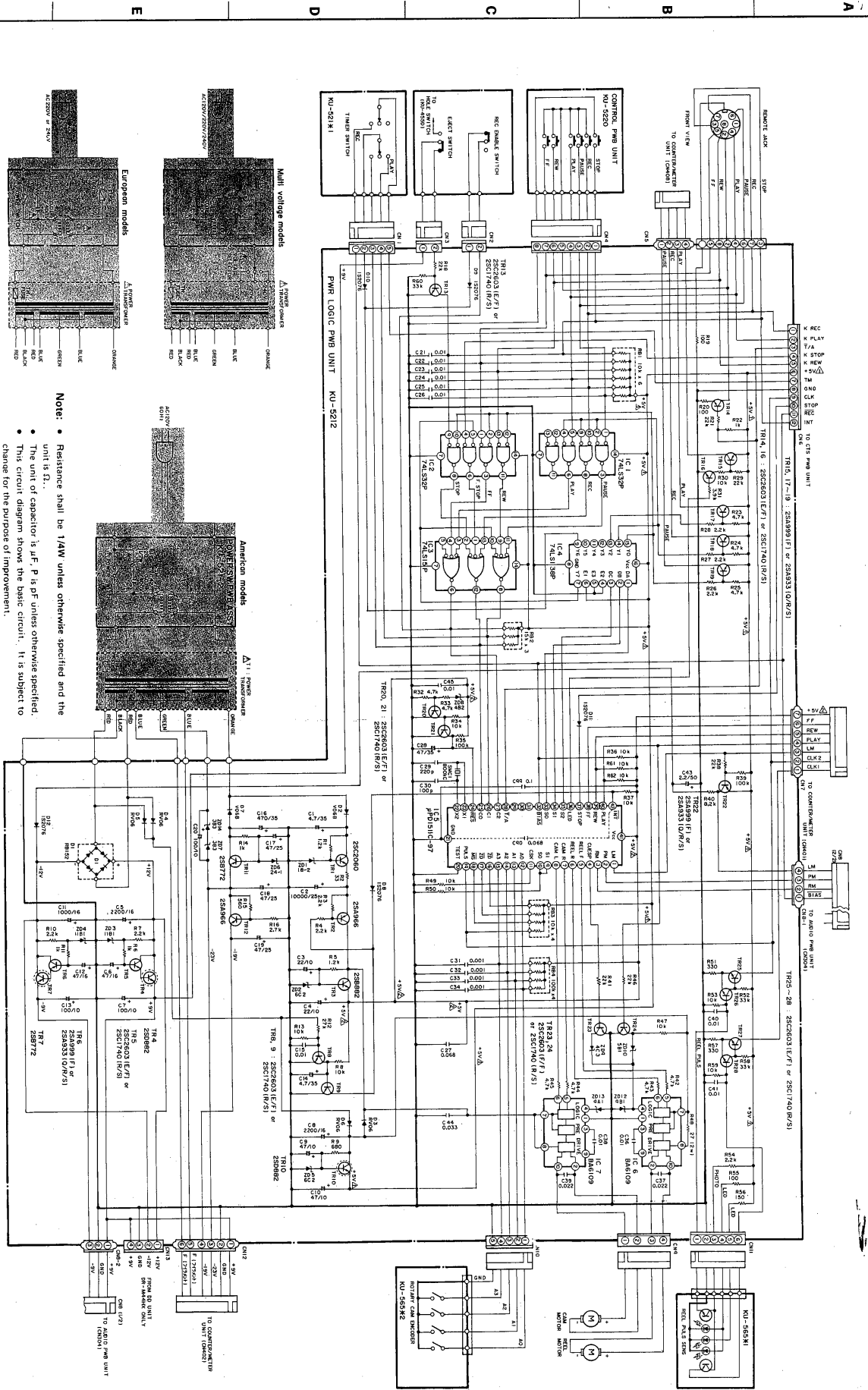

Note:

- Resistance shall be 1/4W unless otherwise specified and the unit is Ω.
- The unit of capacitor is μF. P is pF unless otherwise specified.
- This circuit diagram shows the basic circuit. It is subject to change for the purpose of improvement.
- Parts marked with Δ are of importance in respect to the safety, use the specified type without fail.

1 2 3 4 5 6 7 8

P. W. BOARD OF KU-5212 POWER AND LOGIC UNIT

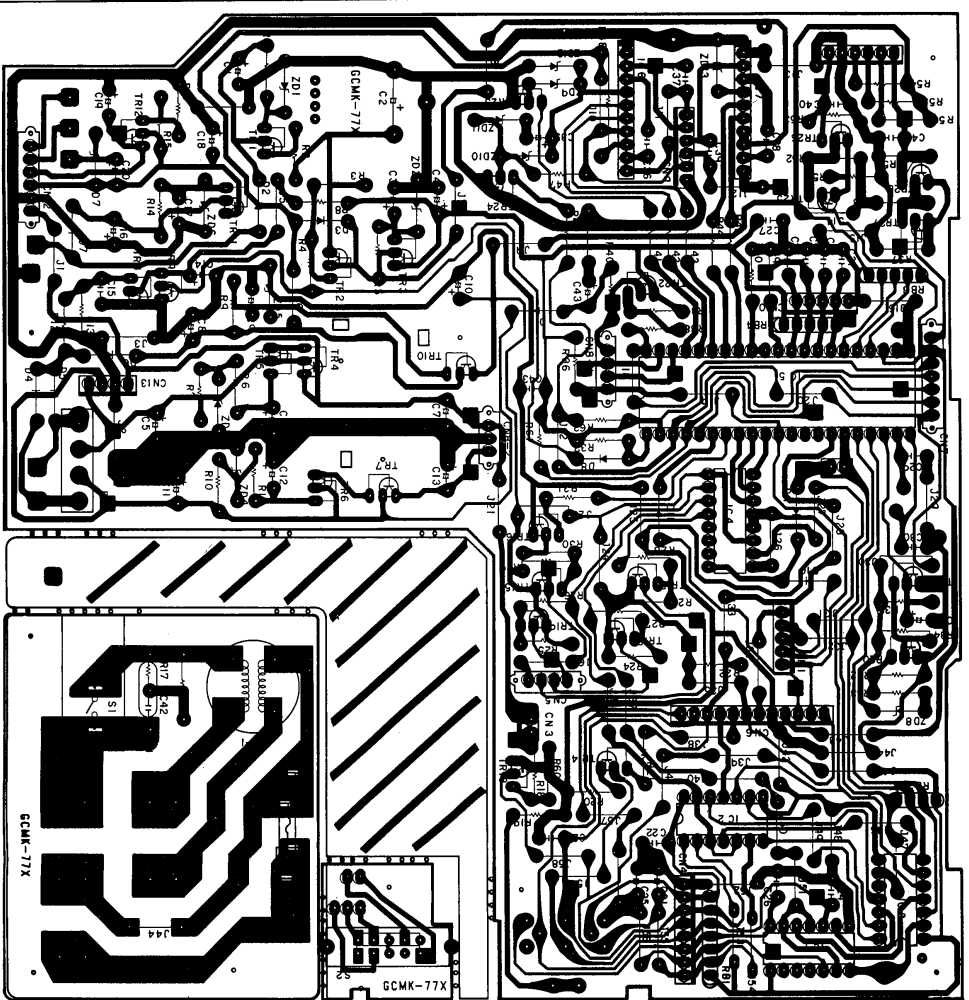

P. W. BOARD OF KU-5221 CONTROL UNIT (DR-M44HX)

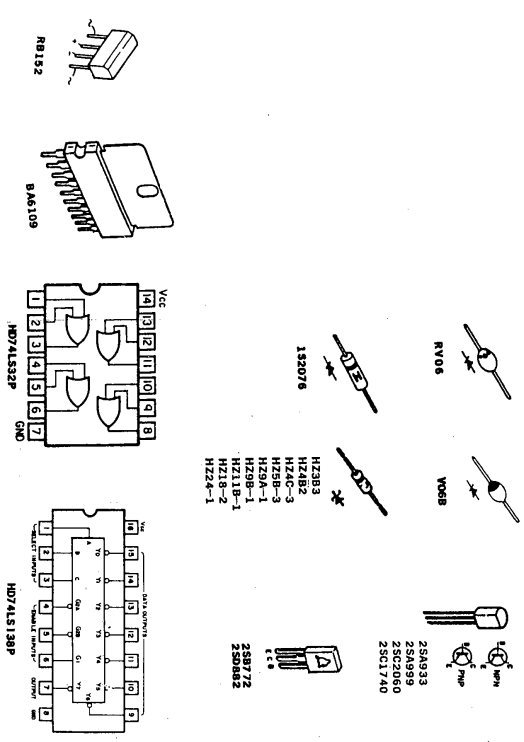
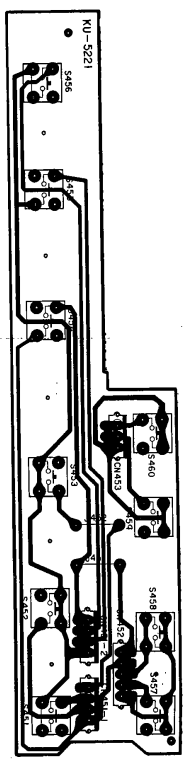

SCHEMATIC DIAGRAM OF FL COUNTER UNIT (DR-M44HX)

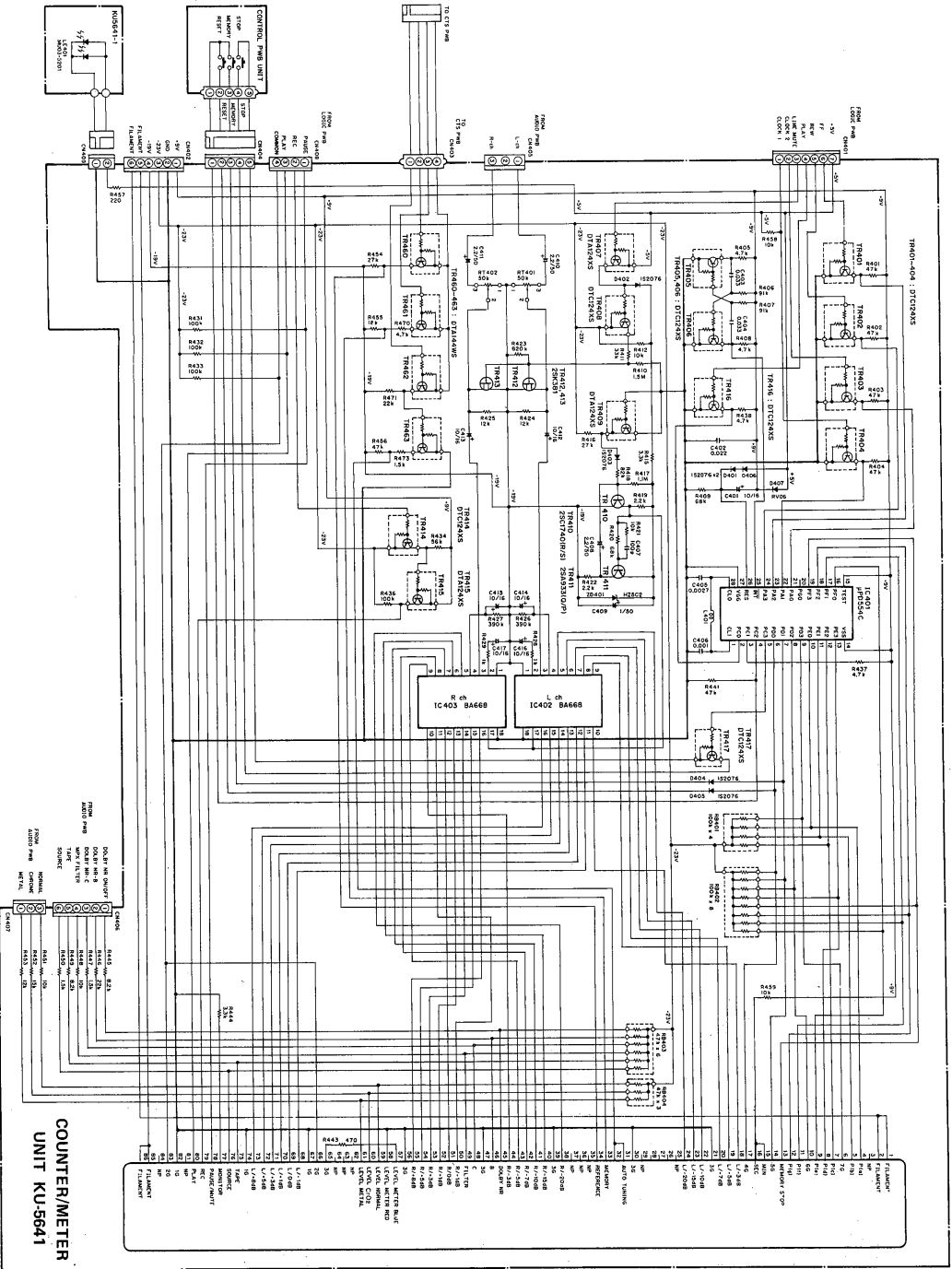

Note: • Resistance shall be 1/4W unless otherwise specified and the unit is Ω.
 • The unit of capacitor is μF, P is pF unless otherwise specified.
 • This circuit diagram shows the basic circuit. It is subject to change for the purpose of improvement.

COUNTER/METER UNIT KU-5641

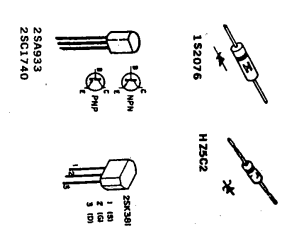
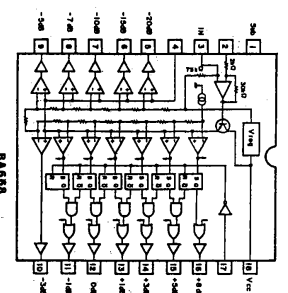

P. W. BOARD OF KU-5641 FL COUNTER UNIT

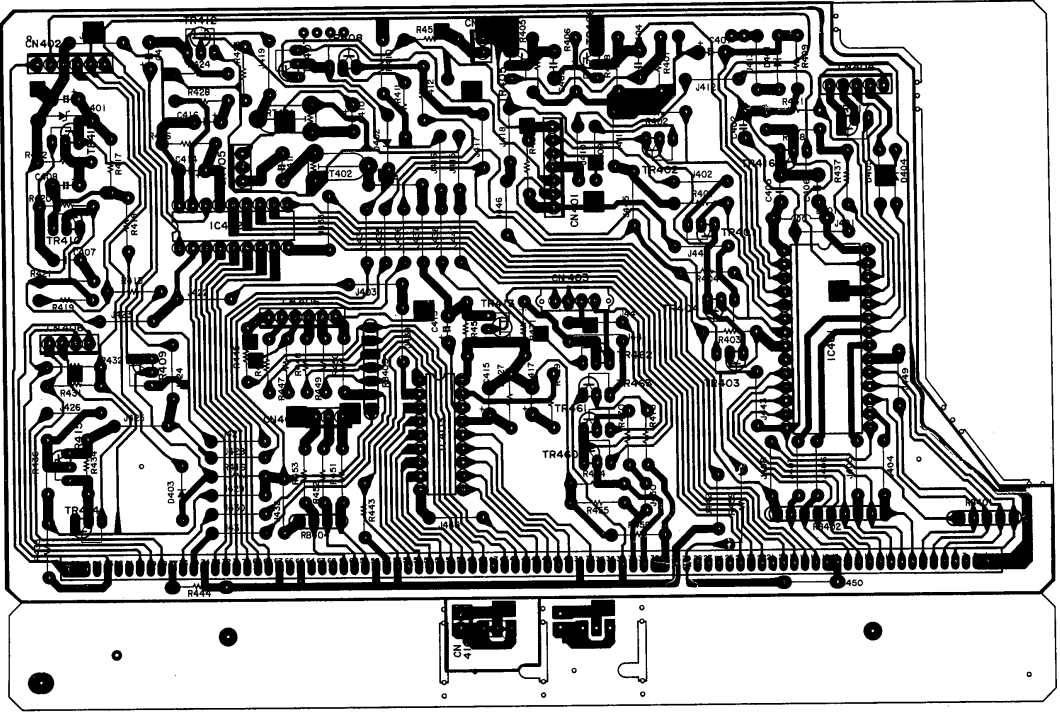

FL COUNTER METER TERMINAL FUNCTION TABLE

Termi- nal Number	Name	Function	Termi- nal Number	Name	Function
1	F	Filament	46	P(S9)	[B] display plate
2	F	Filament	47	3G	Static display grid
3	NP	—	48	P(S10)	[C] display plate
4	P(a)	Plate (a)	49	P(S11)	[FILTER] display plate
5	P(b)	Plate (b)	50	P(R7)	Rich [-1] dB display plate
6	P(b)	Counter-4 digit grid	51	P(R8)	Rich [0] dB display plate
7	P(c)	Plate (c)	52	P(R9)	Rich [+1] dB display plate
8	P(d)	Plate (d)	53	P(R10)	Rich [+3] dB display plate
9	P(e)	Plate (e)	54	P(R11)	Rich [+5] dB display plate
10	6G	Counter-3 digit grid	55	P(R12)	Rich [+8] dB display plate
11	P(f)	Plate (f)	56	3G	Static display grid
12	P(g)	Plate (g)	57	P(X1)	Blue illumination level meter display
13	P(Y1)	[MEMORY STOP] display plate	58	P(X2)	Red illumination level meter display
14	5G	Counter-2 digit grid	59	P(S12)	NORMAL tape transcription limit display plate
15	P(Y2)	[min] display plate	60	P(S13)	CO ₂ tape transcription limit display plate
16	P(Y3)	[SEC] display plate	61	P(S14)	METAL tape transcription limit display plate
17	4G	Counter-1 digit counter	62	NP	—
18	P(L6)	Leh [-3] dB display plate	63	NP	—
19	P(L5)	Leh [-5] dB display plate	64	NP	—
20	P(L4)	Leh [-7] dB display plate	65	3G	Static display grid
21	3G	Static display grid	66	2G	REC., PLAY, and PAUSE/MUTE display grid
22	P(L3)	Leh [-10] dB display plate	67	1G	Static display grid
23	P(L2)	Leh [-15] dB display plate	68	P(L7)	Leh [-1] dB display plate
24	P(L1)	Leh [-20] dB display plate	69	P(L8)	Leh [0] dB display plate
25	NP	—	70	P(L9)	Leh [+1] dB display plate
26	P(S1)	—	71	P(L10)	Leh [+3] dB display plate
27	P(S2)	—	72	P(L11)	Leh [+5] dB display plate
28	P(S3)	—	73	P(L12)	Leh [+8] dB display plate
29	NP	—	74	1G	Static display grid
30	3G	Static display grid	75	P(S15)	[TAPE] display plate
31	P(S4)	[AUTO TUNING] display plate	76	P(S16)	[SOURCE] display plate
32	P(S5)	[MEMORY] display plate	77	P(S17)	[MONITOR] display plate
33	P(S6)	[REFERENCE] display plate	78	P(Z3)	[PAUSE/MUTE] display plate
34	P(S7)	—	79	P(Z2)	[REC] display plate
35	NP	—	80	P(Z1)	[PLAY] display plate
36	NP	—	81	NP	—
37	NP	—	82	1G	Static display grid
38	P(R1)	Rich [-20] dB display plate	83	2G	REC., PLAY, and PAUSE/MUTE display grid
39	3G	Static display grid	84	NP	—
40	P(R2)	Rich [-15] dB display plate	85	F	Filament
41	P(R3)	Rich [-10] dB display plate	86	F	Filament
42	P(R4)	Rich [-7] dB display plate			
43	P(R5)	Rich [-5] dB display plate			
44	P(R6)	Rich [-3] dB display plate			
45	P(S8)	[DOLBY NR] display plate			

SCHEMATIC DIAGRAM OF CTS UNIT (DR-M44HX)

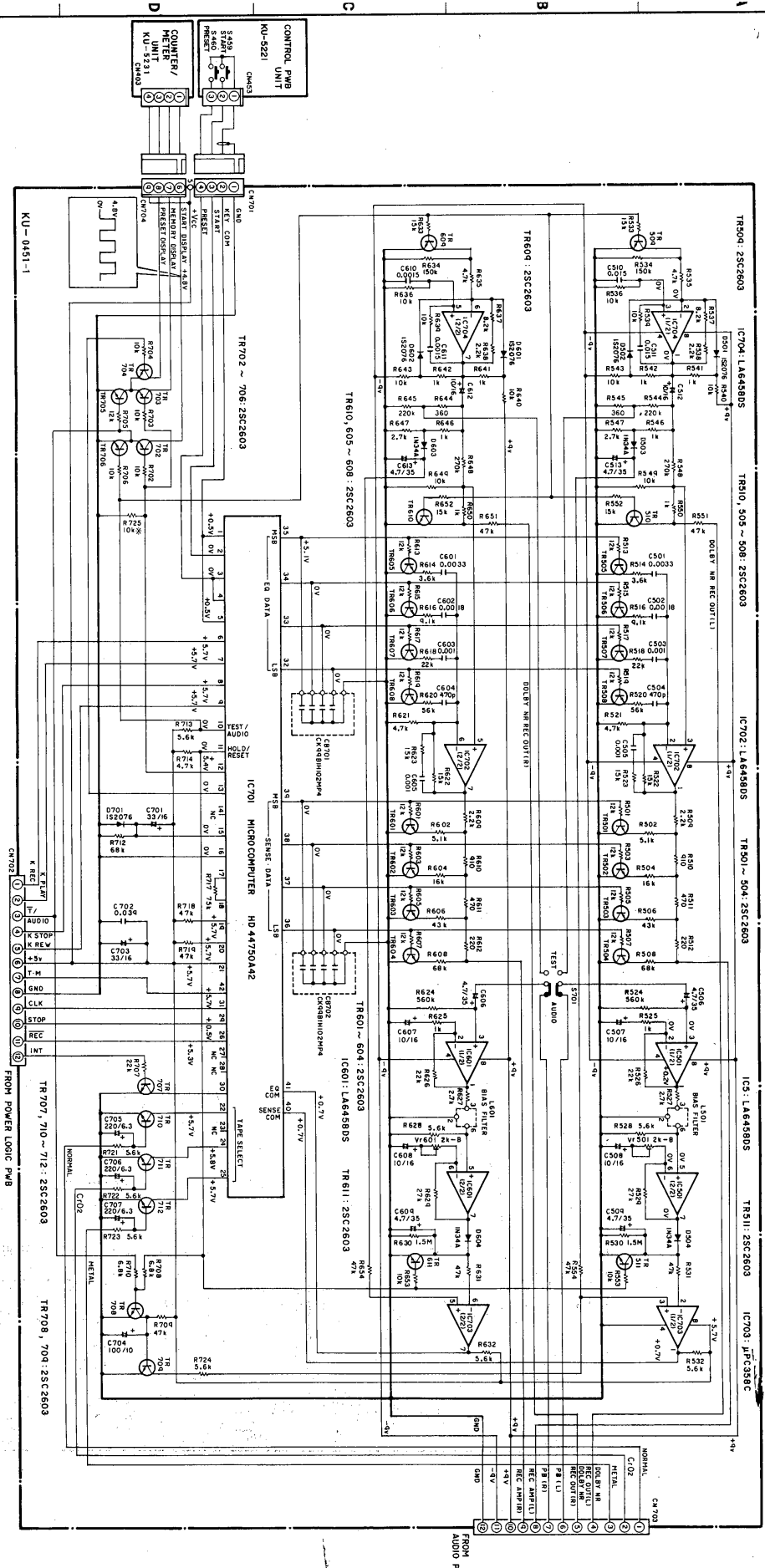

Note: • Resistance shall be 1/W unless otherwise specified and the unit is Ω.
 • The unit of capacitor is μF. P is pF unless otherwise specified.
 • This circuit diagram shows the basic circuit. It is subject to change for the purpose of improvement.

P.W. BOARD OF KU-0451 CTS UNIT

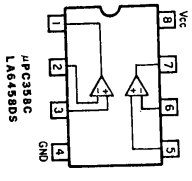
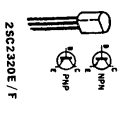
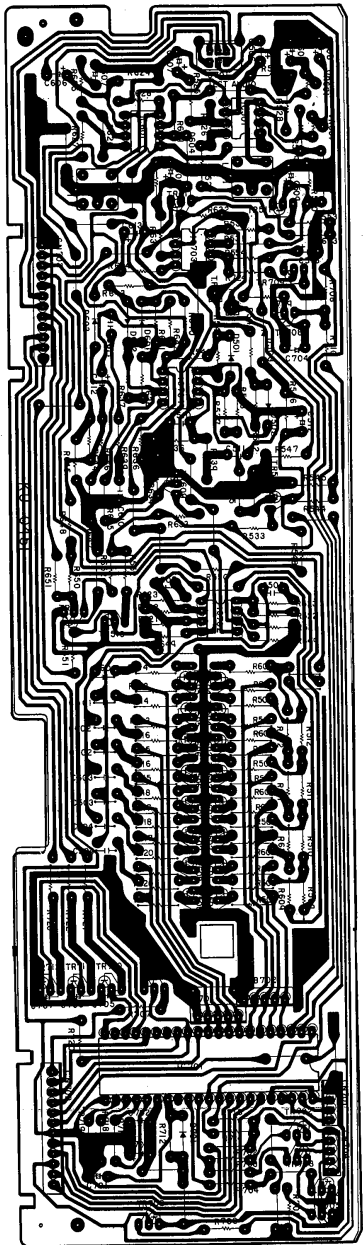

SCHEMATIC DIAGRAM OF CAPSTAN SERVO UNIT (DR-M44HX)

P. W. BOARD OF KU-0455-2 CAPSTAN SERVO UNIT

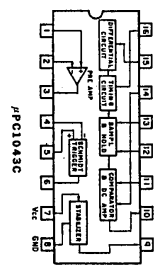
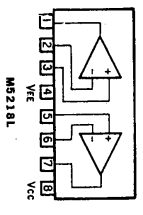
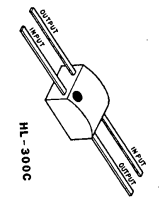
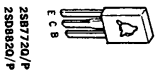
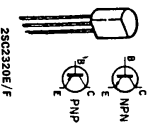
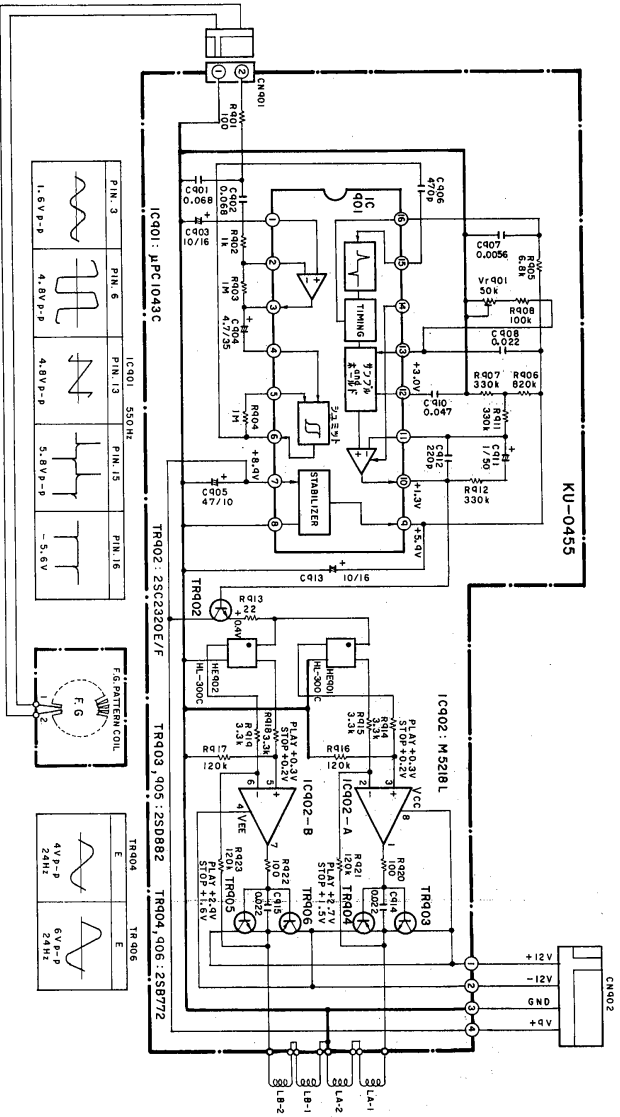

Note: • Resistance shall be 1/4W unless otherwise specified and the unit is Ω.
 • The unit of capacitor is µF. P is pF unless otherwise specified.
 • This circuit diagram shows the basic circuit. It is subject to change for the purpose of improvement.

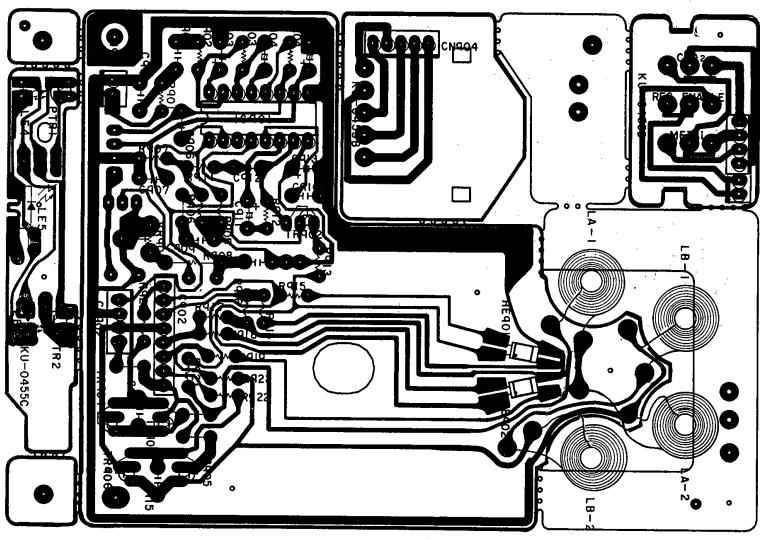

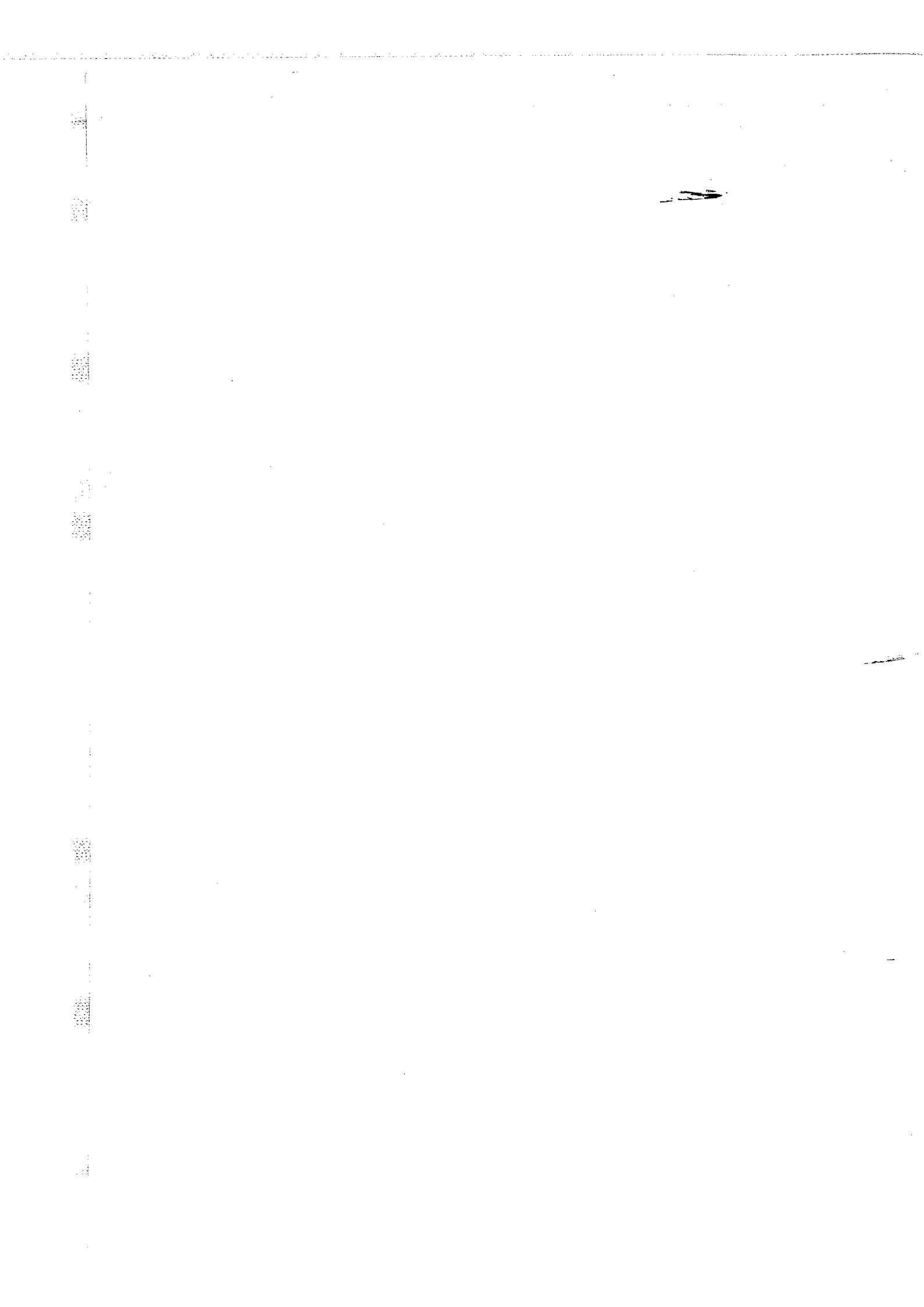

DENON

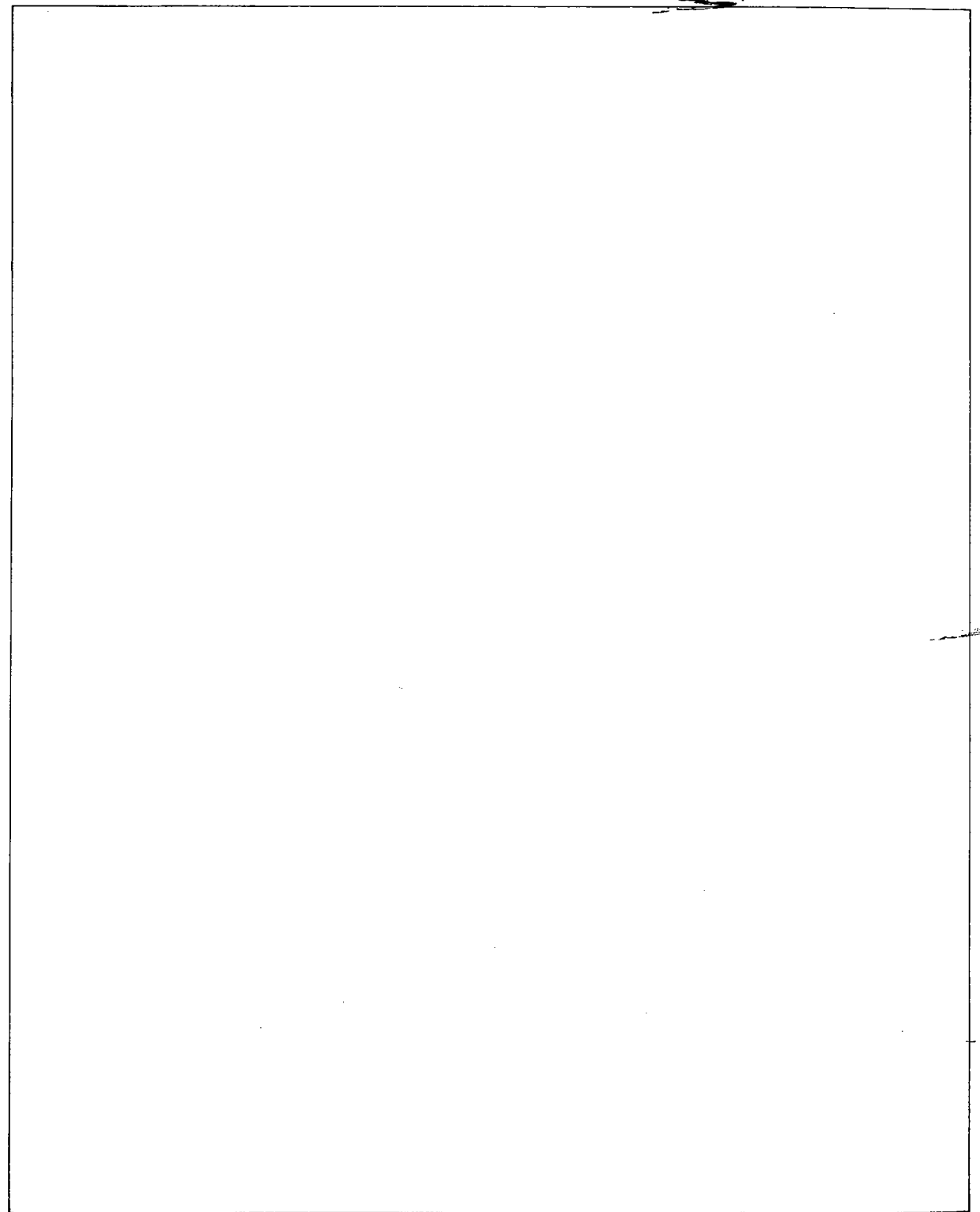

NIPPON COLUMBIA CO., LTD.

No. 14-14, 4-CHOME AKASAKA,
MINATO-KU, TOKYO JAPAN
TEL: 03-584-8111
TLX: JAPANOLA J22591
CABLE: NIPPON COLUMBIA TOKYO